

Dell™ Inspiron™ 8600

Owner's Manual

Model PP02X

Notes, Notices, and Cautions



NOTE: A NOTE indicates important information that helps you make better use of your computer.



NOTICE: A NOTICE indicates either potential damage to hardware or loss of data and tells you how to avoid the problem.



CAUTION: A CAUTION indicates a potential for property damage, personal injury, or death.

Abbreviations and Acronyms

For a complete list of abbreviations and acronyms, see the *Dell Inspiron Help File* (see page 61)

If you purchased a Dell™ n Series computer, any references in this document to Microsoft® Windows® operating systems are not applicable.

Information in this document is subject to change without notice.

© 2004 Dell Inc. All rights reserved.

Reproduction in any manner whatsoever without the written permission of Dell Inc. is strictly forbidden.

Trademarks used in this text: *Dell*, the *DELL* logo, *DellNet*, *Dell Travellite*, *Inspiron*, *Dell Precision*, *Dimension*, *OptiPlex*, *PowerApp*, *PowerEdge*, *PowerConnect*, *PowerVault*, *Axim*, and *Latitude* are trademarks of Dell Inc.; *Intel*, *Pentium*, and *Celeron* are registered trademarks of Intel Corporation; *Microsoft* and *Windows* are registered trademarks of Microsoft Corporation; *Bluetooth* is a registered trademark owned by Bluetooth SIG, Inc. and is used by Dell Inc. under license; *EMC* is a registered trademark of EMC Corporation.

Other trademarks and trade names may be used in this document to refer to either the entities claiming the marks and names or their products. Dell Inc. disclaims any proprietary interest in trademarks and trade names other than its own.

Model PP02X

December 2004

P/N D7711

Rev. A01

Contents

	Finding Information	9
1	A Tour of Your Computer	
	Front View	11
	Left View	15
	Right View	16
	Back View	17
	Bottom View	20
2	Setting Up Your Computer	
	Connecting to the Internet	21
	Setting Up Your Internet Connection	21
	Modem and Internet Connection Problems	22
	Setting Up a Printer	23
	Printer Cable	23
	Connecting a USB Printer	23
	Printer Problems	24
	Setting Up the Docking Device to Connect to a Network	25
	Power Protection Devices	25
	Surge Protectors	25
	Line Conditioners	25
	Uninterruptible Power Supplies	26
	Turning Off Your Computer	26

3 Using Batteries and Module Bay Devices

Using a Battery	27
Battery Performance	27
Checking the Battery Charge	28
Charging the Battery	29
Removing a Battery	30
Installing a Battery	30
Storing a Battery	31
Power Problems	31
About the Module Bay	31
Checking the Charge on the Second Battery	32
Removing and Installing Devices While the Computer Is Turned Off	32
If the Device Screw Is Not Installed	33
If the Device Screw Is Installed	34
Removing and Installing Devices While the Computer Is Running	35
If the Device Screw Is Not Installed	36
If the Device Screw Is Installed	37

4 Using the Keyboard and Touch Pad

Numeric Keypad	39
Keyboard Shortcuts	40
System Functions	40
Battery	40
CD or DVD Tray	40
Display Functions	40
Radios (Including Wireless Networking and Bluetooth®)	40
Power Management	41
Speaker Functions	41
Microsoft® Windows® Logo Key Functions	41
Touch Pad	42
Customizing the Touch Pad	43

Touch Pad or Mouse Problems	43
External Keyboard Problems	43
Unexpected Characters	44
5 Using CDs, DVDs, and Other Multimedia	
Copying CDs and DVDs.	45
How to Copy a CD or DVD.	45
Using Blank CD-Rs, CD-RWs, DVD+Rs, and DVD+RWs	46
Helpful Tips	46
Connecting Your Computer to a TV or Audio Device	47
S-Video Connection.	47
Composite Video Connection	48
Enabling the Display Settings for a TV	50
6 Setting Up a Home and Office Network	
Connecting to a Network Adapter.	53
Network Setup Wizard.	54
Network Problems	54
Connecting to a Wireless Local Area Network.	54
Determining Your Network Type	54
Connecting to a Wireless Network in Microsoft® Windows® XP	55
7 Solving Problems	
Finding Solutions.	59
Accessing Help	61
Error Messages	61
Video and Display Problems.	62
If the display is blank	62
If the display is difficult to read	63
If only part of the display is readable.	64
Scanner Problems	64

Drive Problems	64
If you cannot save a file to a floppy drive	64
If you have problems with a hard drive.	65
PC Card Problems	66
General Program Problems	66
A program crashes	66
A program stops responding	67
Error messages appear.	67
E-Mail Problems	67
If Your Computer Gets Wet	67
If You Drop or Damage Your Computer	68
Resolving Other Technical Problems	69
Drivers	69
What Is a Driver?	69
Identifying Drivers	70
Reinstalling Drivers and Utilities	70
Manually Reinstalling Drivers for Windows XP	71
Restoring Your Operating System	71
Using Microsoft Windows XP System Restore	71
Using Dell PC Restore by Symantec	73
Resolving Software and Hardware Incompatibilities	74

8 Adding and Replacing Parts

Adding Memory	77
Adding a Mini PCI Card	81
Adding a Modem	84
Replacing the Hard Drive	87

9 Appendix

Specifications	89
Standard Settings	95
Overview	95
Viewing the System Setup Screens	96
System Setup Screens	96
Commonly Used Options	96
Dell Technical Support Policy (U.S. Only)	98
Definition of "Dell-Installed" Software and Peripherals	98
Definition of "Third-Party" Software and Peripherals.	99
FCC Notices (U.S. Only)	99
Contacting Dell.	100
Index	119

What Are You Looking For?

- Latest drivers for my computer
- Answers to technical service and support questions
- Online discussions with other users and technical support
- Documentation for my computer

Find it Here**Dell Support Website — support.dell.com**

NOTE: Select your region to view the appropriate support site.

The Dell Support website provides several online tools, including:

- Solutions — Troubleshooting hints and tips, articles from technicians, and online courses
- Community — Online discussion with other Dell customers
- Upgrades — Upgrade information for components, such as memory, the hard drive, and the operating system
- Customer Care — Contact information, order status, warranty, and repair information
- Downloads — Drivers, patches, and software updates
- Reference — Computer documentation, product specifications, and white papers

-
- How to use Windows XP
 - Documentation for my computer
 - Documentation for devices (such as a modem)

Windows Help and Support Center

- 1** Click the **Start** button and click **Help and Support**.
 - 2** Type a word or phrase that describes your problem and click the arrow icon.
 - 3** Click the topic that describes your problem.
 - 4** Follow the instructions on the screen.
-

A Tour of Your Computer

Front View

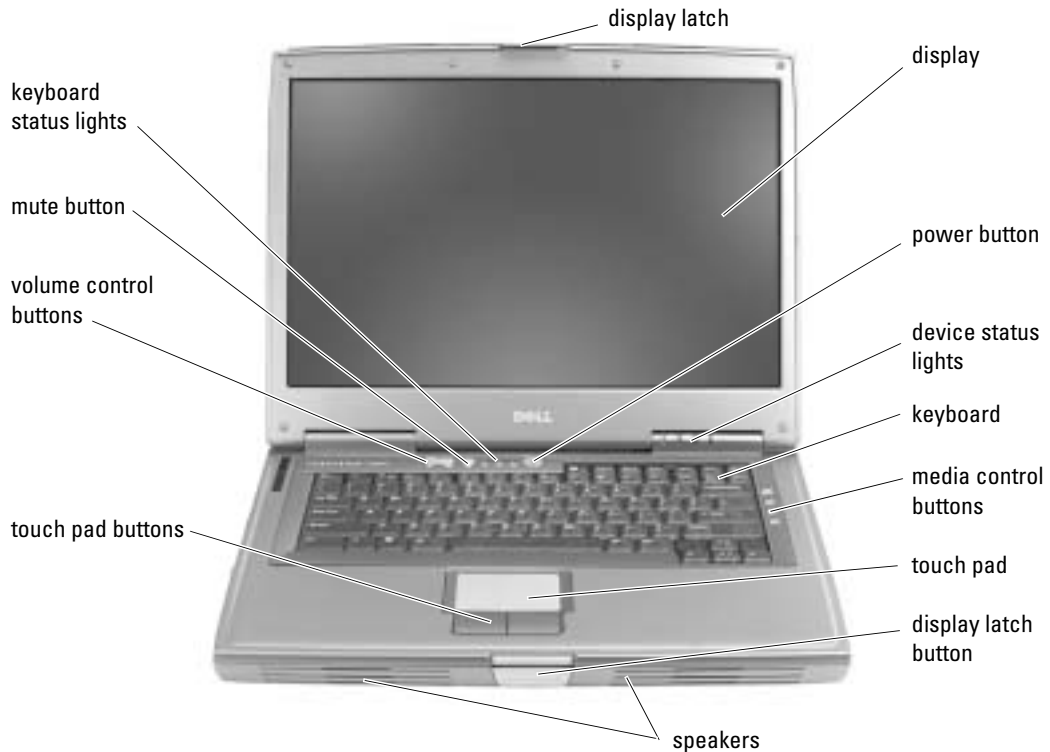

DISPLAY LATCH — Keeps the display closed.

DISPLAY — For more information about your display, see the *Dell Inspiron* help file. To access the help file, see page 61.

POWER BUTTON — Press the power button to turn on the computer or to enter or exit a power management mode.



NOTICE: To avoid losing data, turn off your computer by performing a Microsoft® Windows® shutdown rather than by pressing the power button.

If the computer stops responding, press and hold the power button until the computer turns off completely (which may take several seconds).

DEVICE STATUS LIGHTS



-
- ⏻
 Turns on when you turn on the computer and blinks when the computer is in a power management mode.

 - 💾
 Turns on when the computer reads or writes data.
NOTICE: To avoid loss of data, never turn off the computer while the 💾 light is flashing.

 - 🔋
 Turns on steadily or blinks to indicate battery charge status. If it is off, you may not have a battery in your computer.

 - 📶
 Turns on when Bluetooth® wireless technology is enabled.
NOTE: Bluetooth is an optional feature, so the 📶 light turns on only if you ordered Bluetooth with your computer. For more information, see the documentation that came with your Bluetooth technology products.
 To turn off only the Bluetooth functionality, right-click the 📶 icon in the system tray and select **Disable Bluetooth Radio**.
 To quickly enable or disable all wireless devices, press <Fn><F2>.

If the computer is connected to an electrical outlet, the  light operates as follows:

- Solid green: The battery is charging.
- Flashing green: The battery is almost fully charged.

If the computer is running on a battery, the  light operates as follows:

- Off: The battery is adequately charged (or the computer is turned off).
- Flashing orange: The battery charge is low.
- Solid orange: The battery charge is critically low.

KEYBOARD — The keyboard includes a numeric keypad as well as the Microsoft® Windows® logo key. For information on supported keyboard shortcuts, see page 40.

MEDIA CONTROL BUTTONS — Control CD and DVD playback.

TOUCH PAD — Touch pad and touch pad buttons provide the functionality of a mouse. See page 42 for more information.

DISPLAY LATCH BUTTON — Press this button to release the display latch and open the display.

SPEAKERS — To adjust the volume of the integrated speakers, press the volume control buttons or volume control keyboard shortcuts. For more information, see page 41.



TOUCH PAD BUTTONS — Touch pad buttons provide the functionality of a mouse. See the *Dell Inspiron* help file for more information. To access the help file, see page 61.

VOLUME CONTROL BUTTONS — Press these buttons to adjust the volume.

MUTE BUTTON — Press this button to turn off the volume.

KEYBOARD STATUS LIGHTS

The green lights located above the keyboard indicate the following:

	Turns on when the numeric keypad is enabled.
	Turns on when the uppercase letter function is enabled.
	Turns on when the scroll lock function is enabled.

Left View

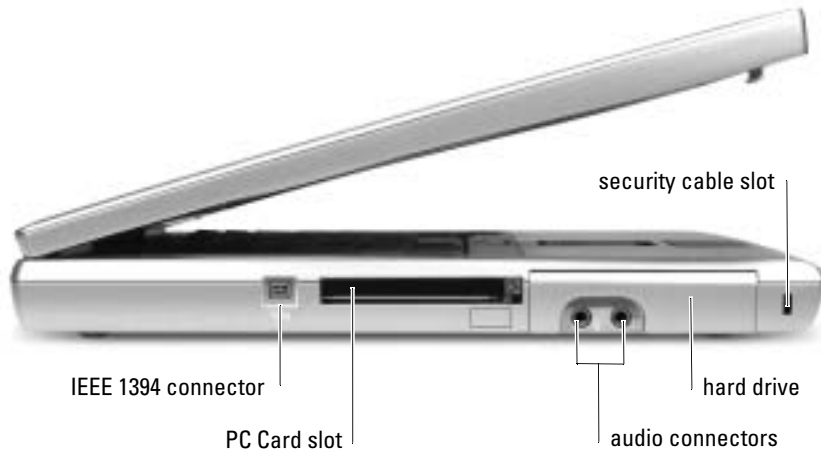



IEEE 1394 CONNECTOR (4-PIN) — Use to attach devices supporting IEEE 1394 high-speed transfer rates, such as some digital video cameras.

PC CARD SLOT — Supports one PC Card, such as a modem or network adapter. For more information, see the *Dell Inspiron* help file. To access the help file, see page 61.

AUDIO CONNECTORS



Attach headphones or speakers to the  connector.

Attach a microphone to the  connector.

HARD DRIVE — Stores software and data.

SECURITY CABLE SLOT — Lets you attach a commercially available antitheft device to the computer. For more information, see the instructions included with the device.

➔ NOTICE: Before you buy an antitheft device, ensure that it will work with the security cable slot.



Right View

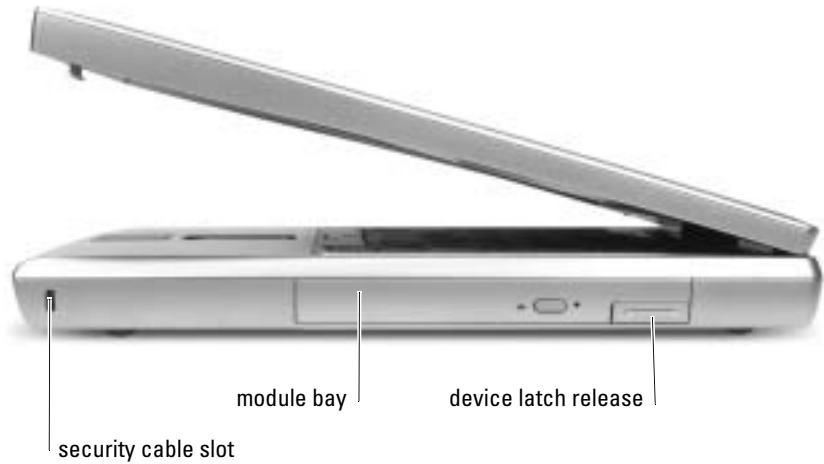

SECURITY CABLE SLOT — Lets you attach a commercially available antitheft device to the computer. For more information, see the instructions included with the device.

NOTICE: Before you buy an antitheft device, ensure that it will work with the security cable slot.



MODULE BAY — You can install devices such as an optical drive or Dell TravelLite™ module in the module bay. For more information, see the *Dell Inspiron* help file. To access the help file, see page 61.

DEVICE LATCH RELEASE — Releases a device. For more information, see the *Dell Inspiron* help file. To access the help file, see page 61.

Back View

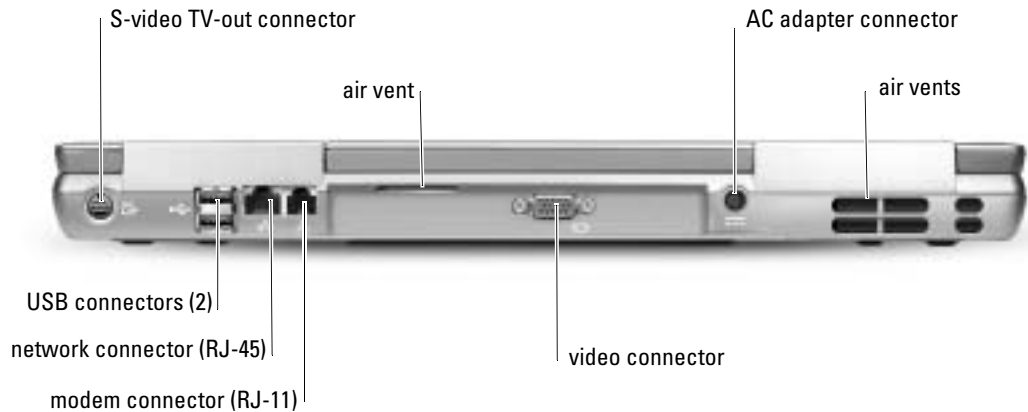

S-VIDEO TV-OUT CONNECTOR



Connects your computer to a TV. For more information, see page 47.

USB CONNECTORS (2)

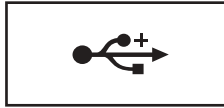

Connect USB devices, such as a mouse, keyboard, or printer. You can also connect the optional floppy drive directly to a USB connector using the optional floppy-drive cable, as shown below.



NETWORK CONNECTOR (RJ-45)

NOTICE: The network connector is slightly larger than the modem connector. To avoid damaging the computer, do not plug a telephone line into the network connector.

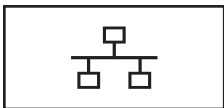

Connects the computer to a network. The green and yellow lights next to the connector indicate activity for both wired and wireless network communications.

For information on using the network adapter, see the online network adapter documentation supplied with your computer.

MODEM CONNECTOR (RJ-11)



To use the internal modem, connect the telephone line to the modem connector.

For additional information on using the modem, see the online modem documentation supplied with your computer.

VIDEO CONNECTOR



Connects an external monitor. For more information, see the *Dell Inspiron* help file. To access the help file, see page 61.

AC ADAPTER CONNECTOR — Attaches an AC adapter to the computer.



The AC adapter converts AC power to the DC power required by the computer. You can connect the AC adapter with your computer turned either on or off.

CAUTION: The AC adapter works with electrical outlets worldwide. However, power connectors and power strips vary among countries. Using an incompatible cable or improperly connecting the cable to the power strip or electrical outlet may cause fire or equipment damage.

NOTICE: When you disconnect the AC adapter cable from the computer, grasp the connector, not the cable itself, and pull firmly but gently to avoid damaging the cable.

AIR VENTS — The computer uses an internal fan to create airflow through the vents, which prevents the computer from overheating.

NOTE: The computer turns on the fan when the computer gets hot. Fan noise is normal and does not indicate a problem with the fan or the computer.

CAUTION: Do not block, push objects into, or allow dust to accumulate in the air vents. Do not store your computer in a low-airflow environment, such as a closed briefcase, while it is running. Restricting the airflow can damage the computer or cause a fire.

Bottom View

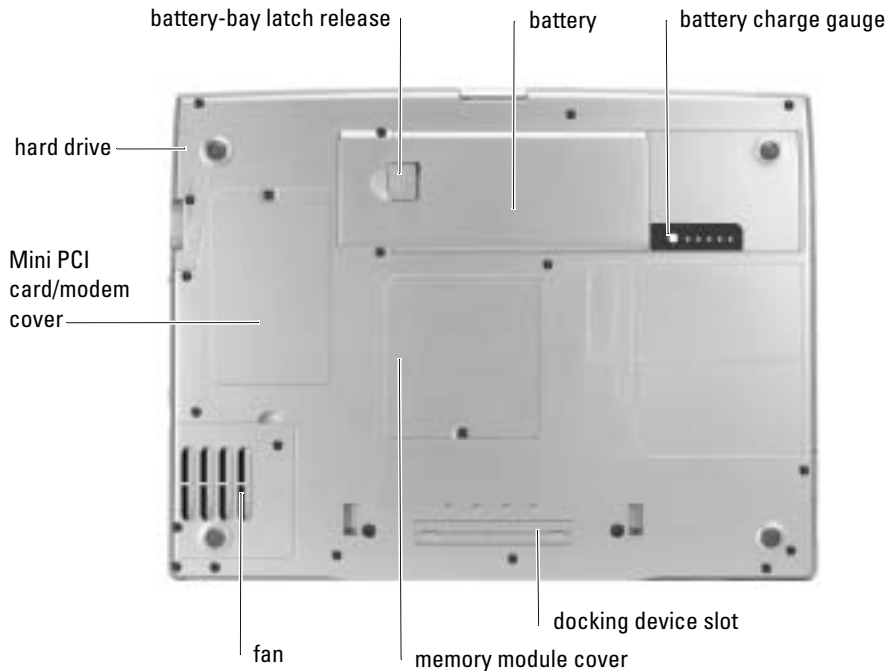

BATTERY-BAY LATCH RELEASE — Releases the battery. See page 30.

BATTERY — When a battery is installed, you can use the computer without connecting the computer to an electrical outlet. See page 30.

BATTERY CHARGE GAUGE — Provides information on the battery charge. See page 29.

DOCKING DEVICE SLOT — Lets you attach your computer to a docking device. See the documentation that came with your docking device for additional information.

MEMORY MODULE COVER — Covers the compartment that contains the memory modules. See page 77.

FAN — The computer uses an internal fan to create airflow through the vents, which prevents the computer from overheating.

 **NOTE:** The computer turns on the fan when the computer gets hot. Fan noise is normal and does not indicate a problem with the fan or the computer.

 **CAUTION:** Do not block, push objects into, or allow dust to accumulate in the air vents. Do not store your computer in a low-airflow environment, such as a closed briefcase, while it is running. Restricting the airflow can damage the computer or cause a fire.

MINI PCI CARD AND MODEM — Covers the compartment that contains the optional modem and optional Mini PCI card. See page 81.

HARD DRIVE — Stores software and data.

Setting Up Your Computer

Connecting to the Internet

 **NOTE:** ISPs and ISP offerings vary by country.

To connect to the Internet, you need a modem or network connection and an Internet service provider (ISP), such as AOL or MSN. Your ISP will offer one or more of the following Internet connection options:

- Dial-up connections that provide Internet access through a phone line. Dial-up connections are considerably slower than DSL and cable modem connections.
- DSL connections that provide high-speed Internet access through your existing phone line. With a DSL connection, you can access the Internet and use your phone on the same line simultaneously.
- Cable modem connections that provide high-speed Internet access through your local cable TV line.

If you are using a dial-up connection, connect a telephone line to the modem connector on your computer and to the telephone wall jack before you set up your Internet connection. See "Back View" on page 17.

If you are using a DSL or cable modem connection, contact your ISP for setup instructions.

Setting Up Your Internet Connection

To set up an AOL or MSN connection:

- 1 Save and close any open files, and exit any open programs.
- 2 Double-click the **MSN Explorer** or **AOL** icon on the Microsoft® Windows® desktop.
- 3 Follow the instructions on the screen to complete the setup.

If you do not have an **MSN Explorer** or **AOL** icon on your desktop or if you want to set up an Internet connection with a different ISP:

- 1 Save and close any open files, and exit any open programs.
- 2 Click the **Start** button and click **Internet Explorer**.
The **New Connection Wizard** appears.
- 3 Click **Connect to the Internet**.

- 4 In the next window, click the appropriate option:
 - If you do not have an ISP and want to select one, click **Choose from a list of Internet service providers (ISPs)**.
 - If you have already obtained setup information from your ISP but you did not receive a setup CD, click **Set up my connection manually**.
 - If you have a CD, click **Use the CD I got from an ISP**.

- 5 Click **Next**.

If you selected **Set up my connection manually**, continue to step 6. Otherwise, follow the instructions on the screen to complete the setup.



NOTE: If you do not know which type of connection to select, contact your ISP.

- 6 Click the appropriate option under **How do you want to connect to the Internet?**, and then click **Next**.

- 7 Use the setup information provided by your ISP to complete the setup.

If you cannot connect to the Internet but have successfully connected in the past, the ISP might have a service outage. Contact your ISP to check the service status, or try connecting again later.

Modem and Internet Connection Problems



NOTICE: Connect the modem to an analog telephone wall jack only. Connecting the modem to a digital telephone network damages the modem.



NOTICE: Modem and network connectors look similar. Do not plug a telephone line into the network connector. See "Back View" on page 17.

CHECK THE TELEPHONE WALL JACK — Disconnect the telephone line from the modem and connect it to a telephone. Listen for a dial tone. Ensure that you have touchtone telephone service. Try connecting the modem to a different telephone wall jack.

Slow connection speeds can be caused by telephone noise as well as by telephone line or network conditions. Contact your telephone company or network administrator for more information.

CONNECT THE MODEM DIRECTLY TO THE TELEPHONE WALL JACK — If you have other telephone devices sharing the line, such as an answering machine, fax machine, surge protector, or line splitter, then bypass them and use the telephone line to connect the modem directly to the telephone wall jack.

CHECK THE CONNECTION — Verify that the telephone line is connected to the modem.

CHECK THE TELEPHONE LINE — Try using a different telephone line. If you are using a line that is 3 m (10 ft) or more in length, try a shorter one.

IRREGULAR DIAL TONE — If you have voice mail service, you might hear an irregular dial tone when you have messages. Contact your telephone company for instructions on restoring a dial tone.

TURN OFF CALL WAITING (CATCH-PHONE) — See your telephone directory for instructions on deactivating this feature. Then adjust the dial-up networking connection properties.

- 1 Click the **Start** button and click **Control Panel**.
- 2 Click **Printers and Other Hardware**, click **Phone and Modem Options**, click the **Dialing Rules** tab, and then click **Edit**.
- 3 In the **Edit Location** window, ensure that **To disable call waiting, dial:** is checked, and then select the proper code as listed in your telephone directory.
- 4 Click **Apply** and click **OK**.
- 5 Close the **Phone and Modems Options** window.
- 6 Close the **Control Panel** window.

VERIFY THAT THE MODEM IS COMMUNICATING WITH WINDOWS —

- 1 Click the **Start** button and click **Control Panel**.
- 2 Click **Printers and Other Hardware** and click **Phone and Modem Options**.
- 3 Click the **Modems** tab.
- 4 Click the COM port for your modem.
- 5 Click **Properties**, click the **Diagnostics** tab, and then click **Query Modem** to verify that the modem is communicating with Windows.

If all commands receive responses, the modem is operating properly.



NOTE: If you can connect to your Internet service provider (ISP), your modem is functioning properly. If you are sure that your modem is working properly and you still experience problems, contact your ISP.

Setting Up a Printer



NOTICE: Complete the operating system setup before you connect a printer to the computer.

See the documentation that came with the printer for setup information, including how to:

- Obtain and install updated drivers.
- Connect the printer to the computer.
- Load paper and install the toner or ink cartridge.
- Contact the printer manufacturer for technical assistance.

Printer Cable

Your printer may not come with a printer cable, so if you purchase a cable separately, ensure that it is compatible with your printer. If you purchased a printer cable at the same time you purchased your computer, the cable may arrive in the computer box.

Connecting a USB Printer



NOTE: You can connect USB devices while the computer is turned on.

- 1 Complete the operating system setup if you have not already done so.
- 2 Install the printer driver if necessary. See the documentation that came with your printer.

- 3 Attach the USB printer cable to the USB connectors on the computer and the printer. The USB connectors fit only one way.

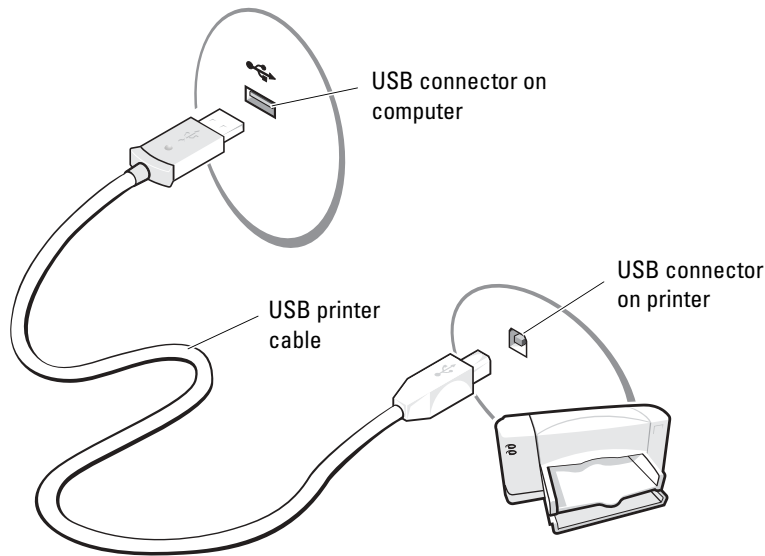

Printer Problems

CHECK THE PRINTER CABLE CONNECTIONS — Ensure that the printer cable is properly connected to the computer (see page 23).

TEST THE ELECTRICAL OUTLET — Ensure that the electrical outlet is working by testing it with another device, such as a lamp.



ENSURE THAT THE PRINTER IS TURNED ON — See the documentation supplied with the printer.

VERIFY THAT WINDOWS® RECOGNIZES THE PRINTER

- 1 Click the Start button.
- 2 Click Control Panel.
- 3 Click Printers and Other Hardware.
- 4 Click View installed printers or fax printers. If the printer model is listed, right-click the printer icon.
- 5 Click Properties, and then click the Ports tab.
- 6 Ensure that the Print to the following port(s): setting is LPT1 (Printer Port).

REINSTALL THE PRINTER DRIVER — See page 70.

Setting Up the Docking Device to Connect to a Network

-  **NOTE:** A network adapter is also referred to as a network interface controller (NIC).
-  **NOTICE:** Do not install a network adapter or a network adapter/modem combination PC Card until you complete the docking device setup.
-  **NOTICE:** To prevent serious operating system problems, do not connect your computer to a docking device until the Windows operating system setup on the computer is complete.

A docking device allows you to more fully integrate your portable computer into a desktop environment.

For instructions and details on setting up a docking device, refer to the documentation that came packaged with the device.

Power Protection Devices

Several devices are available to protect against power fluctuations and failures:

- Surge protectors
- Line conditioners
- Uninterruptible power supplies (UPS)

Surge Protectors

Surge protectors and power strips equipped with surge protection help to prevent damage to your computer from voltage spikes that can occur during electrical storms or following power interruptions. The level of protection is usually commensurate with the cost of the surge protector. Some surge protector manufacturers include warranty coverage for certain types of damage. Carefully read the device warranty when choosing a surge protector. A device with a higher joule rating offers more protection. Compare joule ratings to determine the relative effectiveness of different devices.

-  **NOTICE:** Most surge protectors do not protect against power fluctuations or power interruptions caused by nearby lightning strikes. When lightning occurs in your area, disconnect the telephone line from the telephone wall jack and disconnect your computer from the electrical outlet.

Many surge protectors have a telephone jack for modem protection. See the surge protector documentation for modem connection instructions.

-  **NOTICE:** Not all surge protectors offer network adapter protection. Disconnect the network cable from the network wall jack during electrical storms.

Line Conditioners

-  **NOTICE:** Line conditioners do not protect against power interruptions.

Line conditioners are designed to maintain AC voltage at a fairly constant level.

Uninterruptible Power Supplies

 **NOTICE:** Loss of power while data is being saved to the hard drive may result in data loss or file damage.

 **NOTE:** To ensure maximum battery operating time, connect only your computer to a UPS. Connect other devices, such as a printer, to a separate power strip that provides surge protection.

A UPS protects against power fluctuations and interruptions. UPS devices contain a battery that provides temporary power to connected devices when AC power is interrupted. The battery charges while AC power is available. See the UPS manufacturer documentation for information on battery operating time and to ensure that the device is approved by Underwriters Laboratories (UL).

Turning Off Your Computer

 **NOTICE:** To avoid losing data, turn off your computer by performing a Microsoft® Windows® operating system shutdown, as described next, rather than by pressing the power button.

 **NOTE:** As an alternative to turning off your computer, you can set your computer to enter standby or hibernate mode.

- 1 Save and close any open files, exit any open programs, click the **Start** button, and then click **Turn Off Computer**.
- 2 In the **Turn off computer** window, click **Turn off**.

The computer turns off after the shutdown process finishes.

Using Batteries and Module Bay Devices

Using a Battery

 **CAUTION:** Before performing any of the procedures listed below, read and follow the safety instructions located in the *Product Information Guide*.

Battery Performance

 **NOTE:** Batteries for portable computers are covered only during the initial one-year period of the limited warranty for your computer.

Use a battery to power the computer when it is not connected to an electrical outlet. One battery is supplied as standard equipment in the battery bay.

 **NOTE:** Battery capacity (the time it can hold a charge) decreases over time. Depending on how often the battery is used and the conditions under which it is used, you may need to purchase a new battery during the life of your computer.

Battery operating time varies depending on operating conditions. With average usage, you may expect from 3 to 4 hours from a single fully charged battery. You can install an optional second battery in the module bay to significantly increase operating time. For more information about the second battery, see page 31.

 **NOTE:** The module bay in your computer supports a second battery. The Dell D/Bay does not support a second battery.

Operating time is significantly reduced when you perform operations including, but not limited to, the following:

-  **NOTE:** It is recommended that you connect your computer to an electrical outlet when writing to a CD.
- Using optical drives, especially DVD and CD-RW drives
 - Using wireless communications devices, PC Cards, or USB devices
 - Using high-brightness display settings, 3D screen savers, or other power-intensive programs such as 3D games
 - Running the computer in maximum performance mode

You can check the battery charge before you insert the battery into the computer. You can also set power management options to alert you when the battery charge is low.

 **NOTE:** You can conserve battery life by setting the **Maximum Power Savings** option for your graphics card. For more information, see the documentation that came with your graphics card.

 **CAUTION:** Using an incompatible battery may increase the risk of fire or explosion. Replace the battery only with a compatible battery purchased from Dell. The lithium-ion battery is designed to work with your Dell™ computer. Do not use a battery from other computers with your computer.

 **CAUTION:** Do not dispose of batteries with household waste. When your battery no longer holds a charge, call your local waste disposal or environmental agency for advice on disposing of a lithium-ion battery.

 **CAUTION:** Misuse of the battery may increase the risk of fire or chemical burn. Do not puncture, incinerate, disassemble, or expose the battery to temperatures above 65°C (149°F). Keep the battery away from children. Handle damaged or leaking batteries with extreme care. Damaged batteries may leak and cause personal injury or equipment damage.

Checking the Battery Charge

The Dell QuickSet battery meter, Microsoft® Windows® power meter window and  icon, the battery charge gauge, and the low-battery warning provide information on the battery charge.

For more information about checking the charge on the second battery, see page 32.

Dell QuickSet Battery Meter



Press <Fn><F3> to display the QuickSet Battery Meter.

The Battery Meter screen displays status, charge level, and charge completion time for the primary and second batteries in your computer.

 **NOTE:** It is recommended that you connect your computer to an electrical outlet when writing to a CD.

In addition, when your computer is connected to a docking device (docked), the Battery Meter screen includes a Dock Battery tab, which displays the charge level and current status of the docking device battery.

The following icons appear in the Battery Meter screen:

	<ul style="list-style-type: none"> • The computer or docking device is running on battery power. • The battery is discharging or idle.
	<ul style="list-style-type: none"> • The computer or docking device is connected to an electrical outlet and running on AC power. • The battery is charging.
	<ul style="list-style-type: none"> • The computer or docking device is connected to an electrical outlet and running on AC power. • The battery is not inserted, discharging, idle, or charging.

For more information about QuickSet, right-click the  icon in the taskbar and click Help.

Microsoft Windows Power Meter

The Windows power meter indicates the remaining battery charge. To check the power meter, double-click the  icon on the taskbar. For more information on the **Power Meter** tab, see the *Tell Me How* help file. To access the help file, see page 61.

If the computer is connected to an electrical outlet, a  icon appears.

Charge Gauge

Before you insert a battery, press the status button on the battery charge gauge to illuminate the charge-level lights. Each light represents approximately 20 percent of the total battery charge. For example, if the battery has 80 percent of its charge remaining, four of the lights are on. If no lights appear, the battery has no charge.

Health Gauge

The battery operating time is largely determined by the number of times it is charged. After hundreds of charge and discharge cycles, batteries lose some charge capacity, or battery health. To check the battery health, press and hold the status button on the battery charge gauge for at least 3 seconds. If no lights appear, the battery is in good condition, and more than 80 percent of its original charge capacity remains. Each light represents incremental degradation. If five lights appear, less than 60 percent of the charge capacity remains, and you should consider replacing the battery. See page 93 for more information about the battery operating time.

Low-Battery Warning



NOTICE: To avoid losing or corrupting data, save your work immediately after a low-battery warning. Then connect the computer to an electrical outlet, or install a second battery in the module bay. If the battery runs completely out of power, hibernate mode begins automatically.

A low-battery warning occurs when the battery charge is approximately 90 percent depleted. The computer beeps once, indicating that minimal battery operating time remains. During that time, the speaker beeps periodically. If two batteries are installed, the low-battery warning means that the combined charge of both batteries is approximately 90 percent depleted. The computer enters hibernate mode when the battery charge is at a critically low level. For more information on low-battery alarms, see the *Dell Inspiron* help file. To access the help file, see page 61.

Charging the Battery



NOTE: The AC adapter charges a completely discharged battery in approximately 1 hour with the computer turned off. Charge time is longer with the computer turned on. You can leave the battery in the computer as long as you like. The battery internal circuitry prevents the battery from overcharging.

When you connect the computer to an electrical outlet or install a battery while the computer is connected to an electrical outlet, the computer checks the battery charge and temperature. If necessary, the AC adapter then charges the battery and maintains the battery charge.

If the battery is hot from being used in your computer or being in a hot environment, the battery may not charge when you connect the computer to an electrical outlet.

The battery is too hot to start charging if the  light flashes alternately green and orange. Shut down the computer, disconnect the computer from the electrical outlet and allow the computer and the battery to cool to room temperature. Then connect the computer to an electrical outlet to continue charging the battery.

For more information on resolving problems with a battery, see page 31.

Removing a Battery

For more information about removing the second battery, see page 31.

 **CAUTION: Before performing these procedures, turn off the computer, disconnect it from the electrical outlet, and disconnect the modem from the telephone wall jack.**

- 1 Ensure that the computer is turned off, suspended in hibernate mode, or connected to an electrical outlet.
- 2 If the computer is connected to a docking device (docked), undock it. See the documentation that came with your docking device for instructions.
- 3 Slide and hold the battery-bay (or module-bay) latch release on the bottom of the computer, and then remove the battery from the bay.

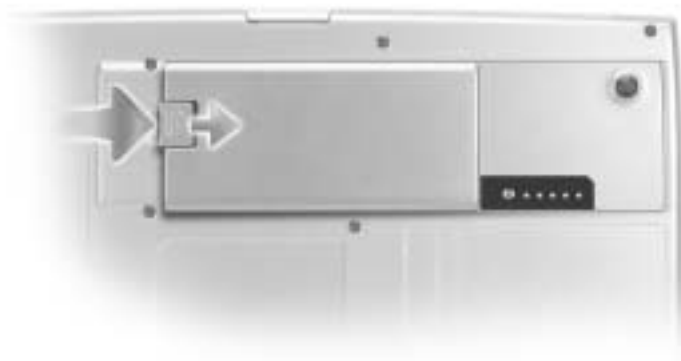

Installing a Battery

Rotate the battery into the bay until the latch release clicks.

For more information about installing the second battery, see page 31.

Storing a Battery

Remove the battery when you store your computer for an extended period of time. A battery discharges during prolonged storage. After a long storage period, recharge the battery fully before you use it.

Power Problems

CHECK THE POWER LIGHT — When the power light is lit or blinking, the computer has power. If the power light is blinking, the computer is in standby mode—press the power button to exit standby mode. If the light is off, press the power button to turn on the computer.

CHECK THE BATTERY TEMPERATURE — If the battery temperature is below 0° C (32° F), the computer will not start up.

CHARGE THE BATTERY — The battery charge may be depleted.

- 1 Reinstall the battery.
- 2 Use the AC adapter to connect the computer to an electrical outlet.
- 3 Turn on the computer.

CHECK THE BATTERY STATUS LIGHT — If the battery status light flashes orange or is a steady orange the battery charge is low or depleted. Connect the computer to an electrical outlet.

If the battery status light flashes green and orange, the battery is too hot to charge. Turn off the computer (see page 26), disconnect the computer from the electrical outlet, and then let the battery and computer cool to room temperature.

If the battery status light rapidly flashes orange, the battery may be defective. Contact Dell (see page 100).

TEST THE ELECTRICAL OUTLET — Ensure that the electrical outlet is working by testing it with another device, such as a lamp.

CHECK THE AC ADAPTER — Check the AC adapter cable connections. If the AC adapter has a light, ensure that the light is on.

CONNECT THE COMPUTER DIRECTLY TO AN ELECTRICAL OUTLET — Bypass power protection devices, power strips, and the extension cable to verify that the computer turns on.

ELIMINATE POSSIBLE INTERFERENCE — Turn off nearby fans, fluorescent lights, halogen lamps, or other appliances.

ADJUST THE POWER PROPERTIES — See the *Dell Inspiron* help file or search for the keyword *standby* in the Help and Support Center. To access the help file, see page 61.

RESEAT THE MEMORY MODULES — If the computer power light turns on but the display remains blank, reseat the memory modules (see page 77).

About the Module Bay



NOTE: You can only use D-Family modules in the module bay.

You can install devices such as a floppy drive, CD drive, CD-RW drive, DVD drive, CD-RW/DVD drive, DVD+RW, Dell TravelLite™ module, second battery, or second hard drive in the module bay.

NOTE: All devices that you install in the module bay, except a second battery, can also be installed in the Dell D/Bay.

Your Dell™ computer ships with an optical drive installed in the module bay. However, the device screw is not installed in the optical drive but packaged separately. When you install your device in the module bay, you can install the device screw.

NOTE: You do not need to install the device screw unless you want to secure the module inside the computer for security purposes.

Checking the Charge on the Second Battery

Before you install a second battery, press the status button on the battery charge gauge to illuminate the charge-level lights. Each light represents approximately 20 percent of the total battery charge. For example, if the battery has 80 percent of its charge remaining, four of the lights are on. If no lights appear, the battery has no charge.

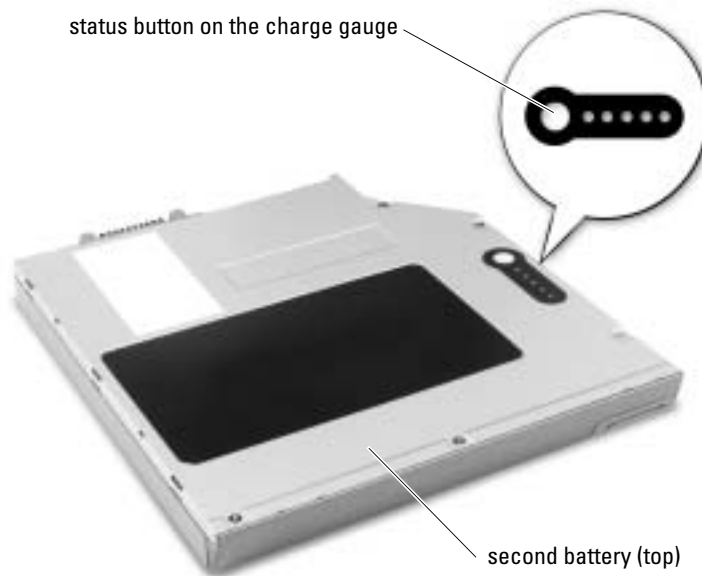

Removing and Installing Devices While the Computer Is Turned Off

Your computer ships with an optical drive installed in the module bay. However, the device screw is not installed in the optical drive but packaged separately. When you install your device in the module bay, you can install the device screw.

 **NOTE:** You do not need to install the device screw unless you want to secure the module inside the computer for security purposes.

If the Device Screw Is Not Installed

 **NOTICE:** To prevent damage to devices, place them in a safe, dry place when they are not installed in the computer. Avoid pressing down on them or placing heavy objects on top of them.

- 1 Press the device latch release.



- 2 Pull the device out of the module bay.



- 3 Insert the new device into the bay, and push the device until you feel a click.

If the Device Screw Is Installed

- 1 Save and close any open files, exit any open programs, and shut down the computer (see page 26).
- 2 If the computer is connected to a docking device (docked), undock it. See the documentation that came with your docking device for instructions.
-  **NOTICE:** To prevent damage to devices, place them in a safe, dry place when they are not installed in the computer. Avoid pressing down on them or placing heavy objects on top of them.
- 3 Close the display and turn the computer over.
- 4 Use a #1 Phillips screwdriver to remove the device screw from the bottom of the computer.
- 5 Press the device latch release.

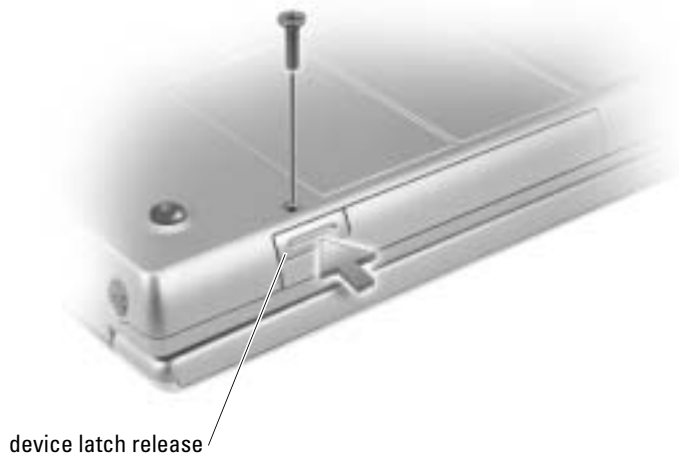

- 6 Pull the device out of the module bay.



-  **NOTICE:** Insert devices into the module bay before you dock and turn on the computer.
- 7 Insert the new device into the bay, and push the device until you feel a click.
- 8 Replace the device screw.
- 9 Turn on the computer.

Removing and Installing Devices While the Computer Is Running

-  **NOTE:** If the device screw is not installed, you can remove and install devices while the computer is running and connected to a docking device (docked).

Your computer ships with an optical drive installed in the module bay. However, the device screw is not installed in the optical drive but packaged separately. When you install your device in the module bay, you can install the device screw.

-  **NOTE:** You do not need to install the device screw unless you want to secure the module inside the computer for security purposes.

If the Device Screw Is Not Installed

1 Double-click the **Safely Remove Hardware** icon on the taskbar.

2 Click the device you want to eject and click **Stop**.

 **NOTICE:** To prevent damage to devices, place them in a safe, dry place when they are not installed in the computer. Avoid pressing down on them or placing heavy objects on top of them.

3 Press the device latch release.



4 Pull the device out of the module bay.



5 Insert the new device into the bay, and push the device until you feel a click. Windows XP automatically recognizes the new device.

6 If necessary, enter your password to unlock your computer.

If the Device Screw Is Installed

- 1 Double-click the **Safely Remove Hardware** icon on the taskbar.
 - 2 Click the device you want to eject and click **Stop**.
 - 3 If the computer is connected to a docking device (docked), undock it. See the documentation that came with your docking device for instructions.
- ➔ NOTICE:** To prevent damage to devices, place them in a safe, dry place when they are not installed in the computer. Avoid pressing down on them or placing heavy objects on top of them.
- 4 Use a #1 Phillips screwdriver to remove the device screw from the bottom of the computer.
 - 5 Press the device latch release.

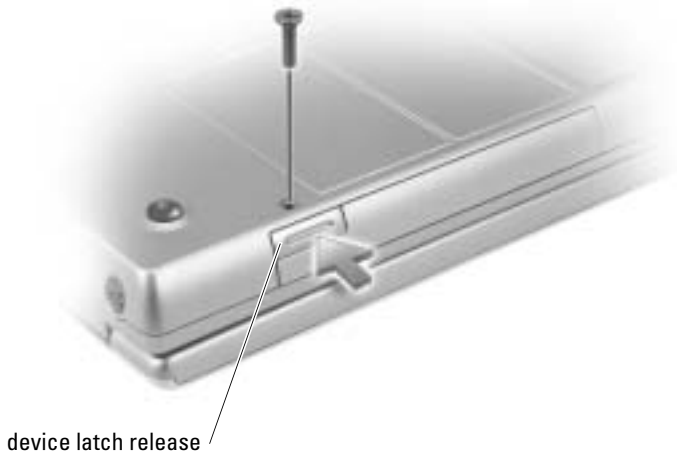

device latch release

- 6 Pull the device out of the module bay.



- 7 Insert the new device into the bay, push the device until you feel a click, and replace the screw. Windows XP automatically recognizes the new device.
- 8 If necessary, enter your password to unlock your computer.

Using the Keyboard and Touch Pad

Numeric Keypad



The keypad numbers and symbols are marked in blue on the right of the keypad keys. To type a number or symbol, ensure that the keypad is enabled, and press <Fn> and the desired key.

The  light indicates that the keypad is active.

Keyboard Shortcuts

System Functions

<Ctrl> <Shift> <Esc>	Opens the Task Manager window
<Num Lk>	Enables and disables the numeric keypad
<Fn> <Num Lk>	Enables and disables the scroll lock

Battery

<Fn> <F3>	Displays the Dell™ QuickSet Battery Meter
-----------	---

CD or DVD Tray

<Fn> <F10>	Requires Dell QuickSet to function. Ejects the tray out of the drive.
------------	---

Display Functions

<Fn> <F8>	Switches the video image to the next display in the following sequence: the integrated display only, the integrated display and an external CRT monitor simultaneously, an external CRT monitor only, the integrated display and an external DVI monitor simultaneously, external DVI monitor only, and external CRT monitor and external DVI monitor simultaneously.
<Fn> + up-arrow key	Increases brightness on the integrated display only (not on an external monitor)
<Fn> + down-arrow key	Decreases brightness on the integrated display only (not on an external monitor)

Radios (Including Wireless Networking and Bluetooth®)

<Fn> <F2>	Enables and disables radios, including wireless networking and Bluetooth
-----------	--

Power Management

<Fn> <Esc>	Activates the power management mode of your choice. You can program this keyboard shortcut on the Advanced tab in the Power Options Properties window.
------------	--

Speaker Functions

If no sound comes from the speakers, press <Fn> <End> and adjust the volume.

<Fn> <Page Up>	Increases the volume of the integrated speakers and external speakers, if attached
<Fn> <Page Dn>	Decreases the volume of the integrated speakers and external speakers, if attached
<Fn> <End>	Enables and disables the integrated speakers and external speakers, if attached

Microsoft® Windows® Logo Key Functions

Windows logo key and <m>	Minimizes all open windows
Windows logo key and <Shift> <m>	Maximizes all windows
Windows logo key and <e>	Runs Windows Explorer
Windows logo key and <r>	Opens the Run dialog box
Windows logo key and <f>	Opens the Search Results dialog box
Windows logo key and <Ctrl> <f>	Opens the Search Results-Computer dialog box (if the computer is connected to a network)
Windows logo key and <Pause>	Opens the System Properties dialog box

To adjust keyboard operation, such as the character repeat rate, open the **Control Panel**, click **Printers and Other Hardware**, and then click **Keyboard**.

Touch Pad

The touch pad detects the pressure and movement of your finger to allow you to move the cursor on the display. Use the touch pad and touch pad buttons as you would use a mouse.

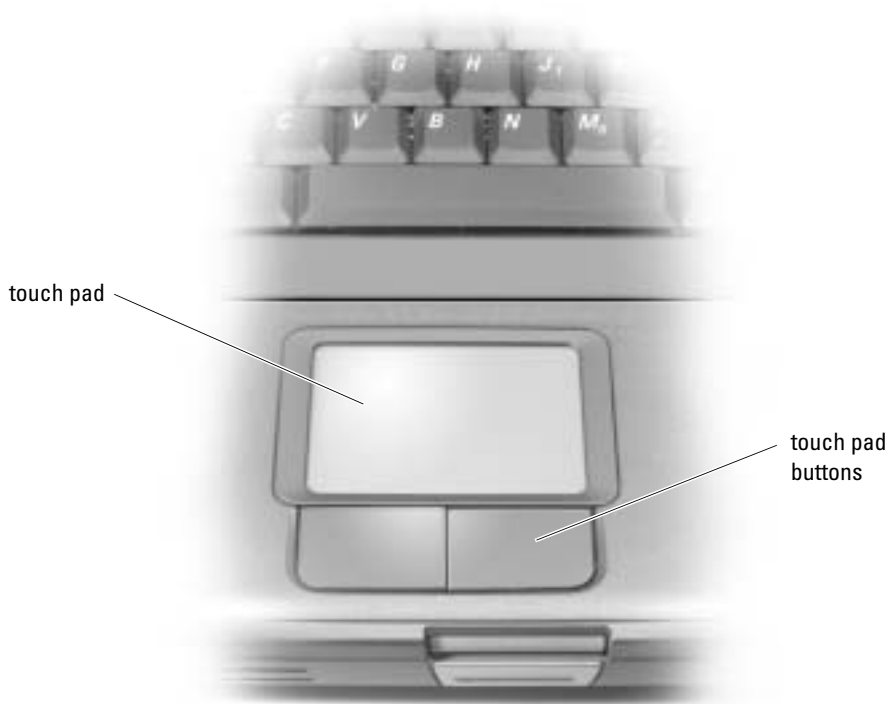

- To move the cursor, lightly slide your finger over the touch pad.
- To select an object, lightly tap once on the surface of the touch pad or use your thumb to press the left touch-pad button.
- To select and move (or drag) an object, position the cursor on the object and tap down-up-down on the touch pad. On the second down motion, leave your finger on the touch pad and move the selected object by sliding your finger over the surface.
- To double-click an object, position the cursor on the object and tap twice on the touch pad or use your thumb to press the left touch-pad button twice.

Customizing the Touch Pad

You can disable the touch pad or adjust their settings by using the **Mouse Properties** window.

- 1 Click the **Start** button, click **Control Panel**, and then click **Printers and Other Hardware**. Click **Mouse**.
- 2 On the **Mouse Properties** window:
 - Click the **Device Select** tab to disable the touch pad.
 - Click the **Pointer** tab to adjust touch pad settings.
- 3 Select the desired settings and click **Apply**.
- 4 Click **OK** to save the settings and close the window.

Touch Pad or Mouse Problems

CHECK THE TOUCH PAD SETTINGS —

- 1 Click the **Start** button, click **Control Panel**, and then click **Printers and Other Hardware**.
- 2 Click **Mouse**.
- 3 Try adjusting the settings.

TO VERIFY THAT THE PROBLEM IS WITH THE MOUSE, CHECK THE TOUCH PAD —

- 1 Shut down the computer (see page 26).
- 2 Disconnect the mouse.
- 3 Turn on the computer.
- 4 At the Windows desktop, use the touch pad to move the cursor around, select an icon, and open it.

If the touch pad operates correctly, the mouse may be defective.

REINSTALL THE TOUCH PAD DRIVER — See page 70.

External Keyboard Problems

CHECK THE KEYBOARD CABLE — Shut down the computer (see page 26). Disconnect the keyboard cable and check it for damage.

If you are using a keyboard extension cable, disconnect it and connect the keyboard directly to the computer.

CHECK THE EXTERNAL KEYBOARD —

- 1 Turn off the computer, wait 1 minute, and turn it on again.
- 2 Verify that the numbers, capitals, and scroll lock lights on the keyboard blink during the boot routine.
- 3 From the Windows® desktop, click the **Start** button, point to **All Programs**, point to **Accessories**, and click **Notepad**.
- 4 Type some characters on the external keyboard and verify that they appear on the display.

If you cannot verify these steps, you may have a defective external keyboard.

TO VERIFY THAT THE PROBLEM IS WITH THE EXTERNAL KEYBOARD, CHECK THE INTEGRATED KEYBOARD —

- 1 Turn off the computer.
- 2 Disconnect the external keyboard.
- 3 Turn on the computer.
- 4 From the Windows desktop, click the **Start** button, point to **All Programs**, point to **Accessories**, and click **Notepad**.
- 5 Type some characters on the integrated keyboard and verify that they appear on the display.

If the characters appear now but did not with the external keyboard, you may have a defective external keyboard. Contact Dell (see page 100).



NOTE: When you attach an external keyboard, the integrated keyboard remains fully functional.

Unexpected Characters

DISABLE THE NUMERIC KEYPAD — Press <Num Lk> to disable the numeric keypad if numbers are displayed instead of letters. Verify that the numbers lock light is not lit.

Using CDs, DVDs, and Other Multimedia

Copying CDs and DVDs

 **NOTE:** Ensure that you follow all copyright laws when you create CDs or DVDs.

This section applies only to computers that have a CD-R, CD-RW, DVD+RW, DVD+R, or DVD/CD-RW combo drive.

The following instructions show how to make an exact copy of a CD or DVD. You can also use Sonic RecordNow for other purposes, including creating CDs from audio files on your computer and creating MP3 CDs. For instructions, see the Sonic RecordNow documentation that came with your computer. Open Sonic RecordNow, click the question mark icon in the upper-right corner of the window, and then click **RecordNow Help** or **RecordNow Tutorial**.

How to Copy a CD or DVD

 **NOTE:** If you have a DVD/CD-RW combo drive and you experience recording problems, check for available software patches at the Sonic support website at support.sonic.com.

Currently, there are five DVD writable disc formats available: DVD+R, DVD+RW, DVD-R, DVD-RW and DVD-RAM. The DVD-writable drives installed in Dell™ computers will write to DVD+R and DVD+RW media, as well as read DVD-R and DVD-RW media, but the drives will not write to and may not read DVD-RAM media. The commercially available DVD players for home theater systems may or may not read all five formats.

 **NOTE:** Most commercial DVDs have copyright protection and cannot be copied using Sonic RecordNow.

- 1 Click the **Start** button, point to **All Programs**→ **Sonic**→ **RecordNow!**→ **RecordNow!**
- 2 Click either the audio tab or the data tab, depending on the kind of CD or DVD you are planning to copy.
- 3 Click **Exact Copy**.
- 4 To copy the CD or DVD:
 - *If you have one CD or DVD drive*, ensure that the settings are correct and click **Copy**. The computer reads your source CD or DVD and copies it to a temporary folder on your computer hard drive. When prompted, insert a blank CD or DVD into the CD or DVD drive and click **OK**.

- *If you have two CD or DVD drives, select the drive into which you have inserted your source CD or DVD and click **Copy**. The computer copies the data on the CD or DVD to the blank CD or DVD.*

Once you have finished copying the source CD or DVD, the CD or DVD that you have created automatically ejects.

Using Blank CD-Rs, CD-RWs, DVD+Rs, and DVD+RWs

Your CD-RW drive can write to two different types of recording media—CD-Rs and CD-RWs (including High-Speed CD-RWs). Use blank CD-Rs to record music or permanently store data files. After creating a CD-R, you cannot write to that CD-R again without changing your method of recording (see the Sonic documentation for more information). Use blank CD-RWs to write to CDs or to erase, rewrite, or update data on CDs.

Your DVD-writable drive can write to four different types of recording media—CD-Rs, CD-RWs (including High-Speed CD-RWs), DVD+Rs, and DVD+RWs. Blank DVD+Rs can be used to permanently store large amounts of information. After creating a DVD+R disc, you may not be able write to that disc again, depending on whether or not the disc is "finalized" or "closed" (the final stage of the disc creation process). Use blank DVD+RWs when you will need to erase, rewrite, or update the information on that disc later.

Helpful Tips

- Use Microsoft® Windows® Explorer to drag and drop files to a CD-R or CD-RW only after you start Sonic RecordNow and open a RecordNow project.
- You must use CD-Rs to burn music CDs that you want to play in regular stereos. CD-RWs do not play in most home or car stereos.
- You cannot create audio DVDs with Sonic RecordNow.
- Music MP3 files can be played only on MP3 players or on computers that have MP3 software installed.
- Do not burn a blank CD-R or CD-RW to its maximum capacity; for example, do not copy a 650-MB file to a 650-MB blank CD. The CD-RW drive needs 1 or 2 MB of the blank CD to finalize the recording.
- Use a blank CD-RW to practice CD recording until you are familiar with CD recording techniques. If you make a mistake, you can erase the data on the CD-RW and try again. You can also use blank CD-RWs to test music file projects before you record the project permanently to a blank CD-R.

See the Sonic support website at support.sonic.com for additional information.

Connecting Your Computer to a TV or Audio Device

NOTE: Video and audio cables for connecting your computer to a TV or other audio device are not included with your computer. Cables may be purchased at most consumer electronics stores. The composite TV-out adapter cable is available for purchase from Dell.

Your TV has either an S-video input connector or a composite video-input connector. Depending on what type of connector is available on your TV, you can use a commercially available S-video cable or composite video cable to connect your computer to your TV. For a TV with only a composite video-input connector, you must also use a composite TV-out adapter cable, which is available from Dell.

The audio connector on the side of the computer enables you to connect the computer to your TV or audio device, using a commercially available audio cable.

NOTE: See the diagrams at the beginning of each subsection to help you determine which method of connection you should use.

When you finish connecting the video and audio cables between your computer and your TV, you must enable your computer to work with the TV. See "Enabling the Display Settings for a TV" to ensure that the computer recognizes and works properly with the TV.

S-Video Connection

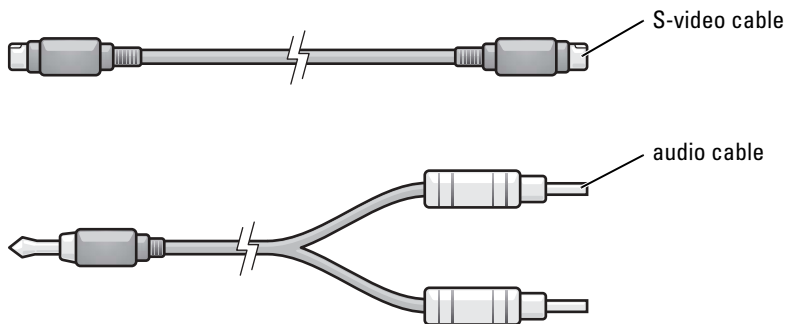

- 1 Turn off the computer and the TV and/or audio device that you want to connect.
- 2 Plug one end of the S-video cable in to the S-video TV-out connector on the computer.

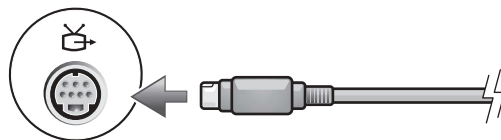

- 3 Plug the other end of the S-video cable in to the S-video input connector on your TV.

- 4 Plug the single-connector end of the audio cable in to the headphone connector on your computer.

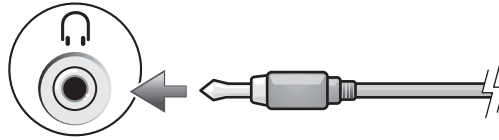

- 5 Plug the two RCA connectors on the other end of the audio cable in to the audio input connectors on your TV or other audio device.
- 6 Turn on the TV, turn on any audio device that you connected (if applicable), and then turn on the computer.
- 7 See "Enabling the Display Settings for a TV" to ensure that the computer recognizes and works properly with the TV.

Composite Video Connection

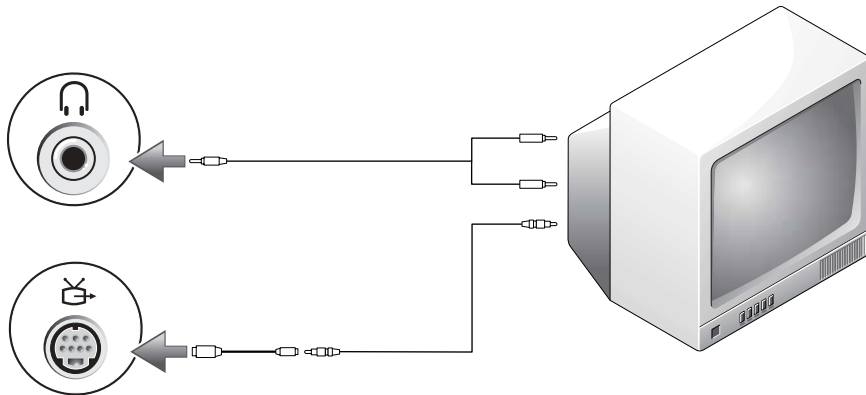

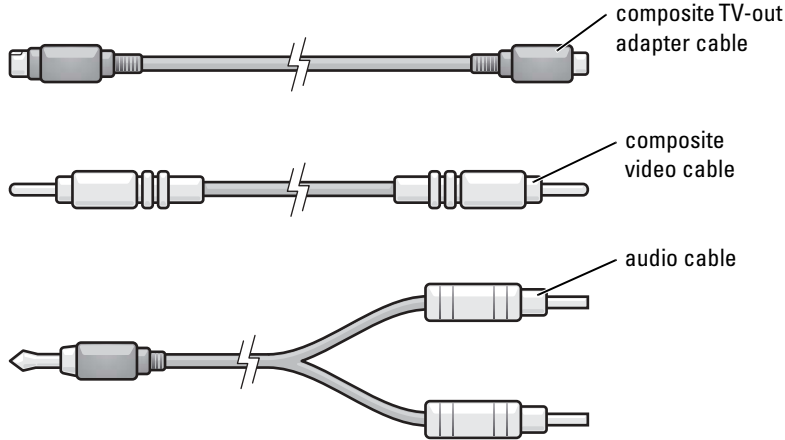

- 1 Turn off the computer and the TV and/or audio device that you want to connect.
- 2 Connect the composite TV-out adapter cable to the S-video TV-out connector on the computer.

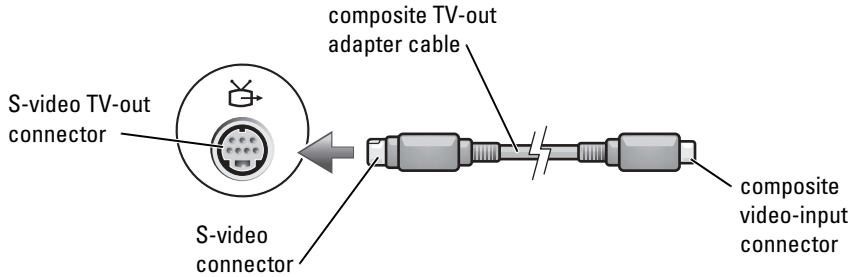

- 3 Plug one end of the composite video cable in to the composite video-input connector on the composite TV-out adapter cable.



- 4 Plug the other end of the composite video cable in to the composite video-input connector on the TV.

- 5 Plug the single-connector end of the audio cable in to the headphone connector on the computer.

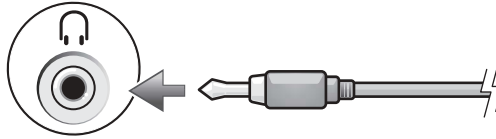

- 6 Plug the two RCA connectors on the other end of the audio cable in to the audio input connectors on your TV or other audio device.
- 7 Turn on the TV and any audio device that you connected (if applicable), and then turn on the computer.
- 8 See "Enabling the Display Settings for a TV" to ensure that the computer recognizes and works properly with the TV.

Enabling the Display Settings for a TV

Your computer may have either an ATI video-controller card, an NVIDIA video-controller card, or an integrated video controller. See the following subsection that corresponds to the video controller installed in your computer.

ATI Video-Controller Card

 **NOTE:** Ensure that you properly connect the TV before you enable the display settings.

- 1 Click the **Start** button and click **Control Panel**.
- 2 Click **Appearances and Themes**.
- 3 Under or pick a **Control Panel** icon, click **Display**.
- 4 Click the **Settings** tab and click **Advanced**.
- 5 Click the **Displays** tab.
- 6 Click the upper-left corner of the **TV** button to enable the TV.
- 7 Click **OK**.

NVIDIA Video-Controller Card

 **NOTE:** Ensure that you properly connect the TV before you enable the display settings.

- 1 Click the **Start** button and click **Control Panel**.
- 2 Click **Appearances and Themes**.
- 3 Under or pick a **Control Panel** icon, click **Display**.
- 4 Click the **Settings** tab and click **Advanced**.
- 5 Click the **Nvidia GeForce** tab.

- 6** On the left side of the menu, click **nView Display Mode**.
- 7** Click **Clone** to enable the television.
- 8** Click **Apply**.
- 9** Click **OK** to confirm the settings change.
- 10** Click **Yes** to keep the new settings.
- 11** Click **OK**.

Setting Up a Home and Office Network

Connecting to a Network Adapter

Before you connect your computer to a network, the computer must have a network adapter installed and a network cable connected to it.

To connect a network cable:

- 1 Connect the network cable to the network adapter connector on the back of your computer.

 **NOTE:** Insert the cable until it clicks into place, and then gently pull it to ensure that it is secure.

- 2 Connect the other end of the network cable to a network connection device, such as a network wall jack.

 **NOTE:** Do not use a network cable with a telephone wall jack.

network adapter connector
on computer

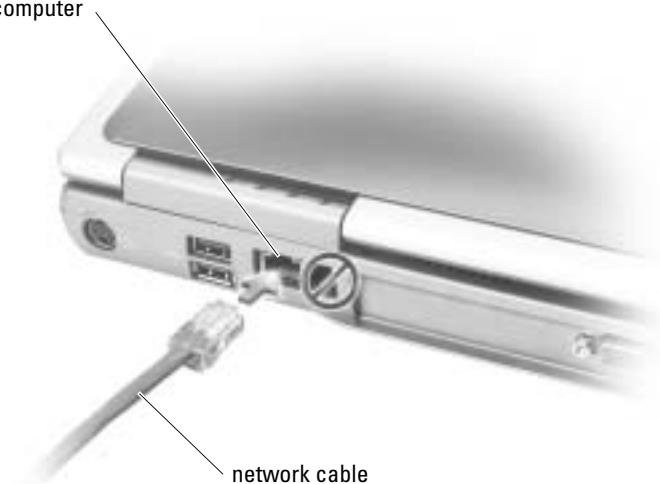

network cable

Network Setup Wizard

The Microsoft® Windows® XP operating system provides a Network Setup Wizard to guide you through the process of sharing files, printers, or an Internet connection between computers in a home or small office.

- 1 Click the **Start** button, point to **All Programs**→**Accessories**→**Communications**, and then click **Network Setup Wizard**.
- 2 On the welcome screen, click **Next**.
- 3 Click **Checklist for creating a network**.

 **NOTE:** Selecting the connection method **This computer connects directly to the Internet** enables the integrated firewall provided with Windows XP.

- 4 Complete the checklist and required preparations.
- 5 Return to the Network Setup Wizard and follow the instructions on the screen.

Network Problems

CHECK THE NETWORK CABLE CONNECTOR — Ensure that the network cable connector is firmly connected to the optional connector on the computer and the network wall jack.

CHECK THE NETWORK LIGHTS ON THE NETWORK CONNECTOR — Green indicates that the network connection is active. If the status light is not green, try replacing the network cable. Amber indicates that the optional network adapter driver is loaded and the adapter is detecting activity.

RESTART THE COMPUTER — Try to log on to the network again.

CONTACT YOUR NETWORK ADMINISTRATOR — Verify that your network settings are correct and that the network is functioning.

Connecting to a Wireless Local Area Network

 **NOTE:** These networking instructions do not apply to internal cards with Bluetooth® wireless technology or cellular products.

Determining Your Network Type

 **NOTE:** Most wireless networks are of the infrastructure type.

Wireless networks fall into two categories—infrastructure networks and ad-hoc networks. An infrastructure network uses routers or access points to connect several computers. An ad-hoc network does not use routers or access points and consists of computers that broadcast to one another. For additional assistance with setting up your wireless connection, go to support.dell.com and search for the keyword *wireless setup*.

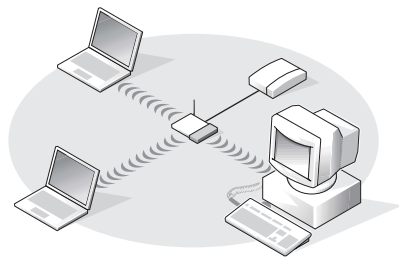

infrastructure network

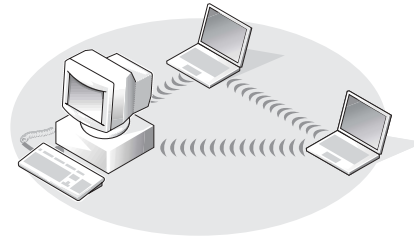

ad-hoc network

Connecting to a Wireless Network in Microsoft® Windows® XP

Your wireless network card requires specific software and drivers in order to connect to a network. The software is already installed. If the software is removed or corrupted, follow the instructions included in the user's guide for your wireless network card. The user's guide is available on the Dell Support website at support.dell.com.

When you turn on your computer, a pop-up appears from the network icon in the notification area (located in the lower-right corner of the Windows desktop) whenever a network, for which your computer is not configured, is detected in the area.



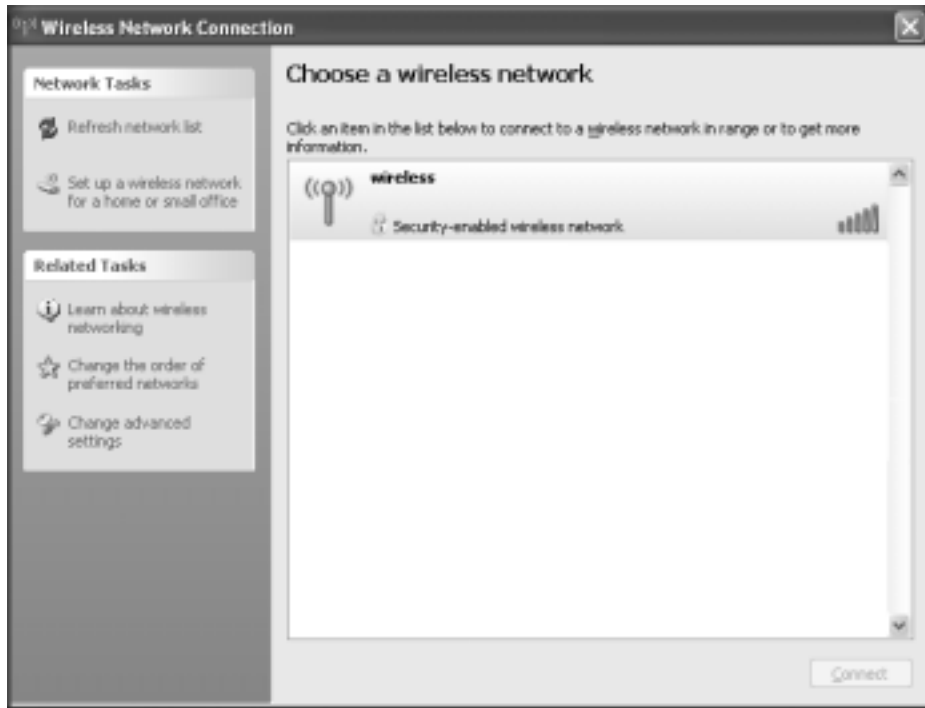

- 1 Click either the pop-up or the network icon to configure your computer for one of the available wireless networks.

The **Wireless Network Connections** window lists the wireless networks available in your area.



- 2 Click to select the network you want to configure, and then click **Connect** or double-click the network name in the list. If you select a secure network (identified by a  icon), you must enter a WEP or WPA key when prompted.

 **NOTE:** Network security settings are unique to your network. Dell cannot provide this information. Your network is configured automatically.

 **NOTE:** Your computer can take up to 1 minute to connect to the network.

After your computer is configured for the wireless network you selected, another pop-up notifies you that your computer is connected to the network you selected.



Thereafter, whenever you log on to your computer in the area of the wireless network, the same pop-up notifies you of the wireless network connection.

Solving Problems

Finding Solutions

Sometimes it's difficult to figure out where to go for answers. Use this chart to quickly find the answers to your questions.

 **NOTE:** If you have a problem with an external device, see the device documentation or contact the manufacturer.

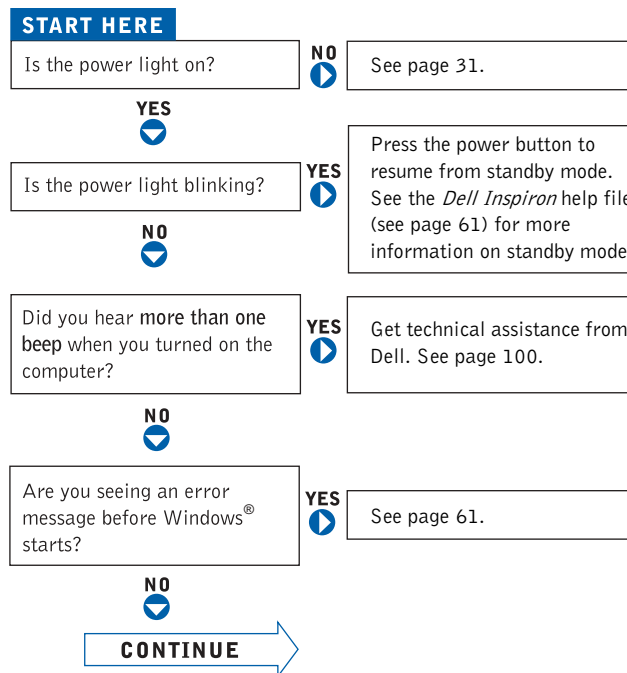

Are you having a problem with...

NO
▼



video or the display?

YES
▶

See page 62.

sound or the speakers?

YES
▶

See page 41.

the printer?

YES
▶

See page 24.

the modem?

YES
▶

See page 22.

the scanner?

YES
▶

See page 64.

the touch pad?

YES
▶

See page 43.

the external keyboard?

YES
▶

See page 43.

unexpected characters?

YES
▶

See page 44.

the hard drive or a disk drive?

YES
▶

See page 64.

the network adapter?

YES
▶

See page 54.

Windows error messages?

YES
▶

See page 61.

a program?

YES
▶

See page 66.

the Internet?

YES
▶

See page 22.

your e-mail?

YES
▶

See page 67.

Are you having some other type of problem?

YES
▶

See page 69.

Accessing Help

TO ACCESS THE *DELL INSPIRON* HELP FILE —

- 1 Click the **Start** button and click **Help and Support**.
- 2 Click **User and system guides** and click **User's guides**.
- 3 Click **Dell Inspiron Help**.

TO ACCESS HELP —

- 1 Click the **Start** button and click **Help and Support**.
- 2 Type a word or phrase that describes your problem and click the arrow icon.
- 3 Click the topic that describes your problem.
- 4 Follow the instructions shown on the screen.

Error Messages

If the message is not listed, see the documentation for the operating system or the program that was running at the time the message appeared.

THE FILE BEING COPIED IS TOO LARGE FOR THE DESTINATION DRIVE — The file that you are trying to copy is too large to fit on the disk, or the disk is too full. Try copying the file to a different disk or use a larger capacity disk.

A FILENAME CANNOT CONTAIN ANY OF THE FOLLOWING CHARACTERS: \ / : * ? " < > | — Do not use these characters in filenames.

INSERT BOOTABLE MEDIA — The operating system is trying to boot to a nonbootable floppy disk or CD. Insert a bootable floppy disk or CD.

NON-SYSTEM DISK OR DISK ERROR — A floppy disk is in the floppy drive. Remove the floppy disk and restart the computer.

NOT ENOUGH MEMORY OR RESOURCES. EXIT SOME PROGRAMS AND TRY AGAIN — You have too many programs open. Close all windows and open the program that you want to use.

OPERATING SYSTEM NOT FOUND — Contact Dell (see page 100).

A REQUIRED .DLL FILE WAS NOT FOUND — The program that you are trying to open is missing an essential file. Remove and then reinstall the program.



- 1 Click the **Start** button.
- 2 Click **Control Panel**.
- 3 Click **Add or Remove Programs**.
- 4 Select the program you want to remove.
- 5 Click **Remove** or **Change/Remove** and follow the prompts on the screen.
- 6 See the program documentation for installation instructions.



X:\ IS NOT ACCESSIBLE. THE DEVICE IS NOT READY — Insert a disk into the drive and try again.

Video and Display Problems

If the display is blank

 **NOTE:** If you are using a program that requires a higher resolution than your computer supports, it is recommended that you attach an external monitor to your computer.

CHECK THE  LIGHT — When the  light is blinking, the computer has power.

- If the  light is blinking, the computer is in standby mode—press the power button to exit standby mode.
- If the  light is off, press the power button.
- If the  light is on, your power management settings may have caused the display to turn off. Try pressing any key or move the cursor to exit standby mode.

CHECK THE BATTERY — If you are using a battery to power your computer, the battery charge may be depleted. Connect the computer to an electrical outlet using the AC adapter, and turn on the computer.

TEST THE ELECTRICAL OUTLET — Ensure that the electrical outlet is working by testing it with another device, such as a lamp.

CHECK THE AC ADAPTER — Check the AC adapter cable connections. If the AC adapter has a light, ensure that it is on.

CONNECT THE COMPUTER DIRECTLY TO AN ELECTRICAL OUTLET — Bypass power protection devices, power strips, and the extension cable to verify that the computer turns on. To access the help file, see page 61.

ADJUST THE POWER PROPERTIES — Search for the keyword *standby* in the Help and Support Center. For instructions on accessing help files, see page 61.

SWITCH THE VIDEO IMAGE — If your computer is attached to an external monitor, press <Fn> <F8> to switch the video image to the display.

If the display is difficult to read

ADJUST THE BRIGHTNESS — See the *Dell Inspiron* help file for instructions on adjusting the brightness. To access the help file, see page 61.

MOVE THE SUBWOOFER AWAY FROM THE COMPUTER OR MONITOR — If your external speaker system includes a subwoofer, ensure that the subwoofer is at least 60 cm (2 ft) away from the computer or external monitor.

ELIMINATE POSSIBLE INTERFERENCE — Turn off nearby fans, fluorescent lights, halogen lamps, or other appliances.

ROTATE THE COMPUTER TO FACE A DIFFERENT DIRECTION — Eliminate sunlight glare, which can cause poor picture quality.

ADJUST THE WINDOWS DISPLAY SETTINGS —

- 1 Click the **Start** button and click **Control Panel**.
- 2 Click **Appearance and Themes**.
- 3 Click the area you want to change or click the **Display** icon.
- 4 Try different settings for **Color quality** and **Screen resolution**.

SEE "ERROR MESSAGES" — If an error message appears, see page 61.

If only part of the display is readable

CONNECT AN EXTERNAL MONITOR —

- 1 Turn off your computer and connect an external monitor to the computer.
- 2 Turn on the computer and the monitor, and adjust the monitor brightness and contrast controls.

If the external monitor works, the computer display may be defective. Contact Dell (see page 100).

Scanner Problems

CHECK THE POWER CABLE CONNECTION — Ensure that the scanner power cable is firmly connected to a working electrical power source and that the scanner is turned on.

CHECK THE SCANNER CABLE CONNECTION — Ensure that the scanner cable is firmly connected to the computer and to the scanner.

UNLOCK THE SCANNER — Ensure that your scanner is unlocked if it has a locking tab or button.

REINSTALL THE SCANNER DRIVER — See the scanner documentation for instructions.

Drive Problems

 **NOTE:** For information on saving files to a floppy disk, see the *Tell Me How* help file. To access the help file, see page 61.

If you cannot save a file to a floppy drive

ENSURE THAT WINDOWS® RECOGNIZES THE DRIVE — Click the **Start** button and click **My Computer**. If the drive is not listed, perform a full scan with your antivirus software to check for and remove viruses. Viruses can sometimes prevent Windows from recognizing the drive. Insert a bootable disk and restart the computer. Verify that the  light is blinking, indicating normal operation.

ENSURE THAT THE DISK IS NOT WRITE-PROTECTED — You cannot save data to a write-protected disk. See the following figure.

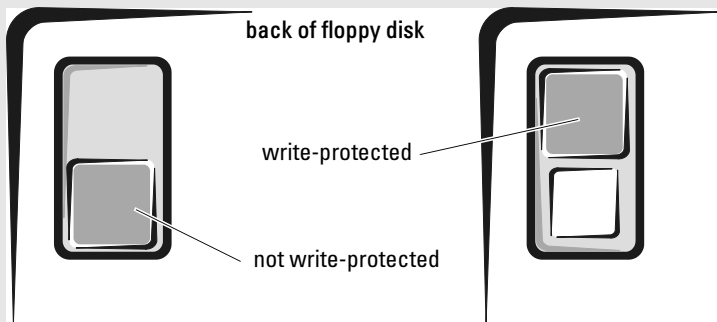

TRY ANOTHER FLOPPY DISK — Insert another disk to eliminate the possibility that the original disk is defective.

REINSTALL THE DRIVE —

- 1 Save and close any open files, exit any open programs, and shut down the computer.
- 2 Remove the drive from the module bay. See page 32 for instructions.
- 3 Reinstall the drive.
- 4 Turn on the computer.

CLEAN THE DRIVE — See "Cleaning Your Computer" in the *Dell Inspiron* help file for instructions. To access the help file, see page 61.

If you have problems with a hard drive

ALLOW THE COMPUTER TO COOL BEFORE TURNING IT ON — A hot hard drive may prevent the operating system from starting. Try allowing the computer to return to room temperature before turning it on.

CHECK THE DRIVE FOR ERRORS —

- 1 Click the **Start** button and click **My Computer**.
- 2 Right-click the drive letter (local disk) that you want to scan for errors, and then click **Properties**.
- 3 Click the **Tools** tab.
- 4 Under **Error-checking**, click **Check Now**.
- 5 Click **Start**.

PC Card Problems

CHECK THE PC CARD — Ensure that the PC Card is properly inserted into the connector.

ENSURE THAT THE CARD IS RECOGNIZED BY WINDOWS® — Double-click the **Unplug or Safely Remove Hardware** icon in the Windows taskbar. Ensure that the card is listed.

IF YOU HAVE PROBLEMS WITH A DELL-PROVIDED PC CARD — Contact Dell (see page 100).

IF YOU HAVE PROBLEMS WITH A PC CARD NOT PROVIDED BY DELL —
Contact the PC Card manufacturer.

General Program Problems

A program crashes

 **NOTE:** Software usually includes installation instructions in its documentation or on a floppy disk or CD.

SEE THE SOFTWARE DOCUMENTATION — Many software manufacturers maintain websites with information that may help you solve the problem. Ensure that you properly installed and configured the program. Reinstall the program if necessary.

A program stops responding

END THE PROGRAM —

- 1 Simultaneously press <Ctrl> <Shift> <Esc>.
- 2 Click the **Applications** tab, and then select the program that is no longer responding.
- 3 Click **End Task**.

Error messages appear

REVIEW "ERROR MESSAGES" — Look up the message and take the appropriate action. See the software documentation.

E-Mail Problems

ENSURE THAT YOU ARE CONNECTED TO THE INTERNET — With the Outlook Express e-mail program open, click **File**. If **Work Offline** has a check mark next to it, click the check mark to remove it and connect to the Internet.

If Your Computer Gets Wet



CAUTION: Perform this procedure only after you are certain that it is safe to do so. If the computer is connected to an electrical outlet, it is recommended that you turn off AC power at the circuit breaker before attempting to remove the power cables from the electrical outlet. Use the utmost caution when removing wet cables from a live power source.

- 1 Shut down the computer (see page 26), disconnect the AC adapter from the computer, and then disconnect the AC adapter from the electrical outlet.
- 2 Turn off any attached external devices, and disconnect them from their power sources and then from the computer.
- 3 Ground yourself by touching one of the metal connectors on the back of the computer.
- 4 Remove the module bay device and any installed PC Cards, and put them in a safe place to dry.
- 5 Remove the battery.
- 6 Wipe off the battery and put it in a safe place to dry.
- 7 Remove the hard drive (see page 87).

- 8 Remove the memory module(s) (see page 77).
- 9 Open the display and place the computer right-side up across two books or similar props to let air circulate all around it. Let the computer dry for at least 24 hours in a dry area at room temperature.



NOTICE: Do not use artificial means, such as a hair dryer or a fan, to speed the drying process.



CAUTION: To help prevent electrical shock, verify that the computer is thoroughly dry before continuing with the rest of this procedure.

- 10 Ground yourself by touching one of the metal connectors on the back of the computer.
- 11 Replace the memory module(s), the memory module cover, and the screw(s).
- 12 Replace the hard drive.
- 13 Replace the module bay device and any PC Cards you removed.
- 14 Replace the battery.
- 15 Turn on the computer and verify that it is working properly.

If the computer does not start, or if you cannot identify the damaged components, contact Dell (see page 100).

If You Drop or Damage Your Computer

- 1 Save and close any open files, exit any open programs, and shut down the computer (see page 26).
- 2 Disconnect the AC adapter from the computer and from the electrical outlet.
- 3 Turn off any attached external devices, and disconnect them from their power sources and then from the computer.
- 4 Remove and reinstall the battery.
- 5 Turn on the computer.

If the computer does not start, or if you cannot identify the damaged components, contact Dell (see page 100).

Resolving Other Technical Problems

GO TO THE DELL SUPPORT WEBSITE — Go to support.dell.com for help with general usage, installation, and troubleshooting questions. See page 98 for a description of the hardware and software support provided by Dell.

E-MAIL DELL — Go to support.dell.com and then click **E-Mail Dell** in the **Communicate** list. Send an e-mail message to Dell about your problem; you can expect to receive an e-mail message from Dell within hours. See page 98 for a description of the hardware and software support provided by Dell.

CONTACT DELL — If you cannot solve your problem using the Dell™ Support website or e-mail service, call Dell for technical assistance (see page 100). See page 98 for a description of the hardware and software support provided by Dell.

Drivers

What Is a Driver?

A driver is a program that controls a device such as a printer, mouse, or keyboard. All devices require a driver program.

A driver acts like a translator between the device and the programs that use the device. Each device has its own set of specialized commands that only its driver recognizes.

Dell ships your computer to you with required drivers already installed—no further installation or configuration is needed.



NOTICE: Ensure that you are installing software appropriate for your operating system.

Many drivers, such as the keyboard driver, come with your Microsoft® Windows® operating system. You may need to install drivers if you:

- Upgrade your operating system.
- Reinstall your operating system.
- Connect or install a new device.

Identifying Drivers

If you experience a problem with any device, identify whether the driver is the source of your problem and, if necessary, update the driver.

- 1 Click the **Start** button and click **Control Panel**.
- 2 Under **Pick a Category**, click **Performance and Maintenance**.
- 3 Click **System**.
- 4 In the **System Properties** window, click the **Hardware** tab.
- 5 Click **Device Manager**.
- 6 Scroll down the list to see if any device has an exclamation point (a yellow circle with a [!]) on the device icon.

If an exclamation point is next to the device name, you may need to reinstall the driver or install a new driver.

Reinstalling Drivers and Utilities



NOTICE: The Dell Support website at support.dell.com provides approved drivers for Dell™ computers. If you install drivers obtained from other sources, your computer might not work correctly.

Using Windows XP Device Driver Rollback

If a problem occurs on your computer after you install or update a driver, use Windows XP Device Driver Rollback to replace the driver with the previously installed version.

- 1 Click the **Start** button and click **Control Panel**.
- 2 Under **Pick a Category**, click **Performance and Maintenance**.
- 3 Click **System**.
- 4 In the **System Properties** window, click the **Hardware** tab.
- 5 Click **Device Manager**.
- 6 Right-click the device for which the new driver was installed and click **Properties**.
- 7 Click the **Drivers** tab.
- 8 Click **Roll Back Driver**.

If Device Driver Rollback does not resolve the problem, then use System Restore (see "Restoring Your Operating System" on page 71) to return your computer to the operating state that existed before you installed the new driver.

Manually Reinstalling Drivers for Windows XP

 **NOTICE:** The Dell Support website at support.dell.com provides approved drivers for Dell™ computers. If you install drivers obtained from other sources, your computer might not work correctly.

- 1 After copying the correct driver files to your hard drive, click the **Start** button and right-click **My Computer**.
- 2 Click **Properties**.
- 3 Click the **Hardware** tab and click **Device Manager**.
- 4 Double-click the type of device for which you are installing the driver (for example, **Modems**).
- 5 Double-click the name of the device for which you are installing the driver.
- 6 Click the **Driver** tab and click **Update Driver**.
- 7 Click **Install from a list or specific location (Advanced)** and click **Next**.
- 8 Click **Browse** and browse to the location to which you previously extracted the driver files.
- 9 When the name of the appropriate driver appears, click **Next**.
- 10 Click **Finish** and restart your computer.

Restoring Your Operating System

You can restore your operating system in the following ways:

- Microsoft Windows XP System Restore returns your computer to an earlier operating state without affecting data files.
- Dell PC Restore by Symantec restores your hard drive to the operating state it was in when you purchased the computer. Dell PC Restore permanently deletes all data on the hard drive and removes any applications installed after you received the computer.

Using Microsoft Windows XP System Restore

The Microsoft Windows XP operating system provides System Restore to allow you to return your computer to an earlier operating state (without affecting data files) if changes to the hardware, software, or other system settings have left the computer in an undesirable operating state. See the Windows Help and Support Center for information on using System Restore. To access help, see page 61.

 **NOTICE:** Make regular backups of your data files. System Restore does not monitor your data files or recover them.

 **NOTE:** The procedures in this document were written for the Windows default view, so they may not work if you set your Dell™ computer to the Windows Classic view.

Creating a Restore Point

- 1 Click the **Start** button and click **Help and Support**.
- 2 Click **System Restore**.
- 3 Follow the instructions on the screen.

Restoring the Computer to an Earlier Operating State

If problems occur after you install a device driver, use Device Driver Rollback (see page 71) to resolve the problem. If that is unsuccessful, then use System Restore.



NOTICE: Before you restore the computer to an earlier operating state, save and close any open files and exit any open programs. Do not alter, open, or delete any files or programs until the system restoration is complete.

- 1 Click the **Start** button, point to **All Programs**→**Accessories**→**System Tools**, and then click **System Restore**.
- 2 Ensure that **Restore my computer to an earlier time** is selected and click **Next**.
- 3 Click a calendar date to which you want to restore your computer.

The **Select a Restore Point** screen provides a calendar that allows you to see and select restore points. All calendar dates with available restore points appear in boldface type.

- 4 Select a restore point and click **Next**.

If a calendar date has only one restore point, then that restore point is automatically selected. If two or more restore points are available, click the restore point that you prefer.

- 5 Click **Next**.

The **Restoration Complete** screen appears after System Restore finishes collecting data and then the computer restarts.

- 6 After the computer restarts, click **OK**.

To change the restore point, you can either repeat the steps using a different restore point, or you can undo the restoration.

Undoing the Last System Restore



NOTICE: Before you undo the last system restore, save and close all open files and exit any open programs. Do not alter, open, or delete any files or programs until the system restoration is complete.

- 1 Click the **Start** button, point to **All Programs**→**Accessories**→**System Tools**, and then click **System Restore**.
- 2 Click **Undo my last restoration** and click **Next**.

Enabling System Restore

If you reinstall Windows XP with less than 200 MB of free hard-disk space available, System Restore is automatically disabled. To see if System Restore is enabled:

- 1 Click the **Start** button and click **Control Panel**.
- 2 Click **Performance and Maintenance**.
- 3 Click **System**.
- 4 Click the **System Restore** tab.
- 5 Ensure that **Turn off System Restore** is unchecked.

Using Dell PC Restore by Symantec

Use Dell PC Restore by Symantec only as the last method to restore your operating system. PC Restore restores your hard drive to the operating state it was in when you purchased the computer. Any programs or files added since you received your computer—including data files—are permanently deleted from the hard drive. Data files include documents, spreadsheets, e-mail messages, digital photos, music files, and so on. If possible, back up all data before using PC Restore.



NOTICE: Using PC Restore permanently deletes all data on the hard drive and removes any applications or drivers installed after you received your computer. If possible, back up the data before using PC Restore.

To use PC Restore:

- 1 Turn on the computer.
During the boot process, a blue bar with www.dell.com appears at the top of the screen.
- 2 Immediately upon seeing the blue bar, press <Ctrl><F11>.
If you do not press <Ctrl><F11> in time, let the computer finish restarting, and then restart the computer again.



NOTICE: If you do not want to proceed with PC Restore, click **Reboot** in the following step.

- 3 On the next screen that appears, click **Restore**.
- 4 On the next screen, click **Confirm**.
The restore process takes approximately 6–10 minutes to complete.
- 5 When prompted, click **Finish** to reboot the computer.



NOTE: Do not manually shut down the computer. Click **Finish** and let the computer completely reboot.

- 6 When prompted, click **Yes**.
The computer restarts. Because the computer is restored to its original operating state, the screens that appear, such as the End User License Agreement, are the same ones that appeared the first time the computer was turned on.

- 7 Click **Next**.

The **System Restore** screen appears and the computer restarts.

- 8 After the computer restarts, click **OK**.

Removing PC Restore



NOTICE: PC Restore enables you to restore your computer's operating system to the condition it was in when you purchased your computer. It is recommended that you *do not* remove PC Restore from your computer, even to gain additional hard drive space. If you remove PC Restore from the hard drive, you cannot ever recall it, and you will never be able to use PC Restore to return your computer's operating system to its original state.

- 1 Log on to the computer as a local administrator.
- 2 In Windows Explorer, go to `c:\dell\utilities\DSR`.
- 3 Double-click the filename `DSRIRRemv2.exe`.



NOTE: If you do not log on as a local administrator, a message appears stating that you that you must do so. Click **Quit** and log on as a local administrator.

If the partition for PC Restore does not exist, a message appears stating that the partition was not found. Click **Quit**; there is no partition to delete.

- 4 Click **OK** to remove the partition.
- 5 Click **Yes** when a confirmation message appears.

The partition is deleted and the `c:\` partition expands to include the newly available disk space. To check the available space, right-click the `c:\` drive in Windows Explorer and select **Properties**.

- 6 Click **Finish** to close the **PC Restore Removal** window.
- 7 Restart the computer.

Resolving Software and Hardware Incompatibilities

Windows XP IRQ conflicts occur if a device either is not detected during the operating system setup or is detected but incorrectly configured.

To check for conflicts on a computer running Windows XP:

- 1 Click the **Start** button and click **Control Panel**.
- 2 Click **Performance and Maintenance** and click **System**.
- 3 Click the **Hardware** tab and click **Device Manager**.
- 4 In the **Device Manager** list, check for conflicts with the other devices.

Conflicts are indicated by a yellow exclamation point (!) beside the conflicting device or a red x if the device has been disabled.

- 5 Double-click any conflict to display the **Properties** window.

If an **IRQ** conflict exists, the **Device** status area in the **Properties** window reports the cards or devices that share the device's **IRQ**.

- 6 Resolve conflicts by reconfiguring the devices or removing the devices from the **Device Manager**.

To use the Windows XP Hardware Troubleshooter:

- 1 Click the **Start** button and click **Help and Support**.
- 2 Type `hardware troubleshooter` in the **Search** field and click the arrow to start the search.
- 3 Click **Hardware Troubleshooter** in the **Search Results** list.
- 4 In the **Hardware Troubleshooter** list, click **I need to resolve a hardware conflict on my computer**, and click **Next**.

Adding and Replacing Parts

The procedures in this section require a small Phillips screwdriver.

Adding Memory

You can increase your computer memory by installing memory modules on the system board. See page 89 for information on the memory supported by your computer. Install only memory modules that are intended for your computer.



NOTE: Memory modules purchased from Dell are covered under your computer warranty.



CAUTION: Before working inside your computer, follow the safety instructions located in the *Product Information Guide*.

- 1 Ensure that the work surface is flat and clean to prevent scratching the computer cover.
- 2 Save and close any open files, exit any open programs, and then shut down the computer (see page 26).
- 3 If the computer is connected to a docking device (docked), undock it. See the documentation that came with your docking device for instructions.
- 4 Disconnect the computer from the electrical outlet.
- 5 Wait 10 to 20 seconds, and then disconnect any attached devices.
- 6 Remove any installed PC Cards, batteries, and module bay devices.



NOTICE: Handle components and cards by their edges, and avoid touching pins and contacts. Ground yourself by touching a metal connector on the back of the computer. Continue to ground yourself periodically during this procedure.

- 7 Turn the computer over, loosen the captive screw from the memory module cover, and then remove the cover.

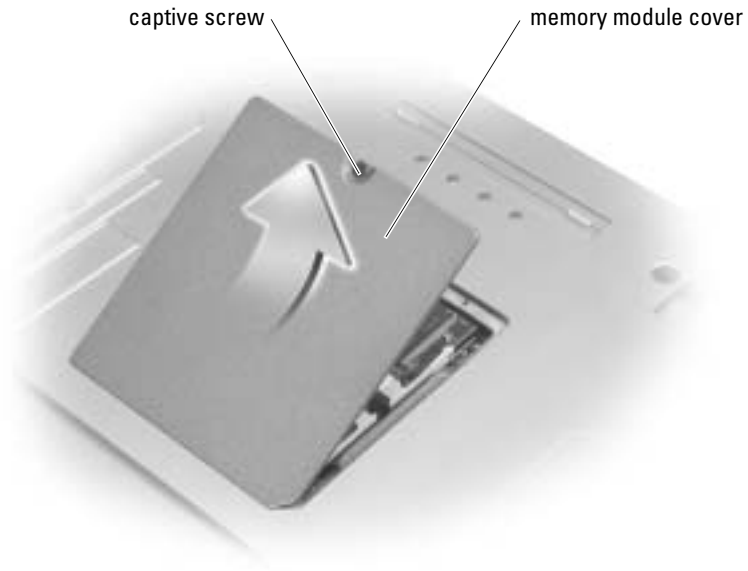

NOTICE: To prevent damage to the memory module connector, do not use tools to spread the memory-module securing clips.

- 8 If you are replacing a memory module, remove the existing module:
 - a Use your fingertips to carefully spread apart the securing clips on each end of the memory module connector until the module pops up.
 - b Remove the module from the connector.

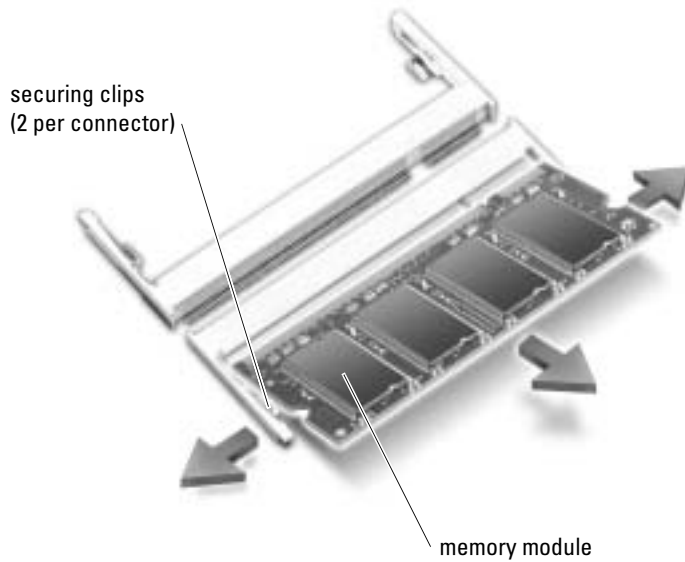

NOTICE: If you need to install memory modules in two connectors, install a memory module in the connector labeled “DIMM A” before you install a module in the connector labeled “DIMM B.” Insert memory modules at a 45-degree angle to avoid damaging the connector.

9 Ground yourself and install the new memory module:

 **NOTE:** If the memory module is not installed properly, the computer may not boot properly. No error message indicates this failure.

a Align the notch in the module edge connector with the tab in the connector slot.

 **NOTICE:** Only hold the module by the shorter, notched ends. Do not push on the longer, outer edge.

b Holding the shorter, notched ends of the module, slide the edge of the module firmly into the connector, and rotate the module down until you feel a click. If you do not feel the click, remove the module and reinstall it.



10 Replace the cover.

 **NOTICE:** If the cover is difficult to close, remove the module and reinstall it. Forcing the cover to close may damage your computer.

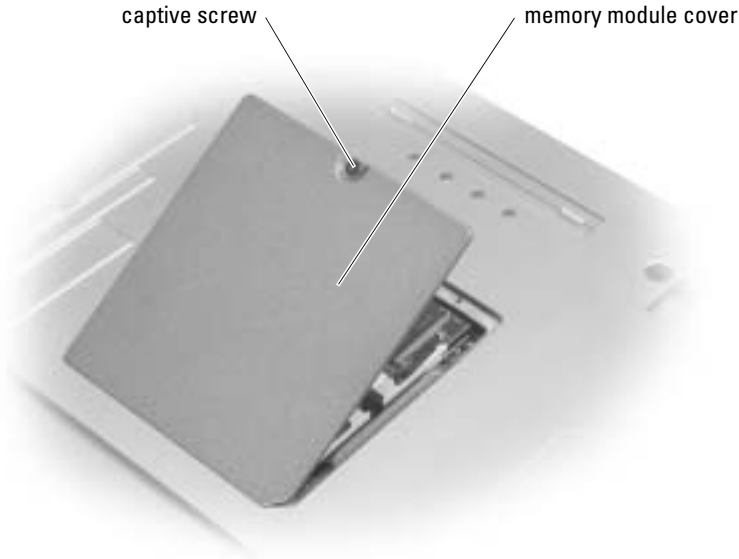

11 Insert the battery into the battery bay, or connect the AC adapter to your computer and an electrical outlet.

12 Turn on the computer.

As the computer boots, it detects the additional memory and automatically updates the system configuration information.

To confirm the amount of memory installed in the computer, click the **Start** button, click **Help and Support**, and then click **Computer Information**.

Adding a Mini PCI Card



CAUTION: FCC rules strictly prohibit users from installing 5 GHz (802.11a, 802.11a/b, 802.11a/b/g) Wireless LAN Mini PCI cards. Under no circumstances should the user install such a device. Only trained Dell service personnel are authorized to install a 5 GHz Wireless LAN Mini PCI card.

If you are removing and/or installing a 2.4 GHz (802.11b, 802.11b/g) Mini PCI Card, please follow the instructions noted below. Only products approved for use in your portable computer may be installed. Approved Mini PCI Cards may be purchased only from Dell.



NOTE: 2.4 GHz Wireless LAN PC Cards may be removed and installed by the user.



CAUTION: Before working inside your computer, follow the safety instructions located in the *Product Information Guide*.

If you ordered a Mini PCI card with your computer, the card is already installed.

- 1 Ensure that the work surface is flat and clean to prevent scratching the computer cover.
 - 2 Save and close any open files, exit any open programs, and then shut down the computer (see page 26).
 - 3 If the computer is connected to a docking device (docked), undock it. See the documentation that came with your docking device for instructions.
 - 4 Disconnect the computer from the electrical outlet.
 - 5 Wait 10 to 20 seconds, and then disconnect any attached devices.
 - 6 Remove any installed PC Cards, batteries, and module bay devices.
- ➔ NOTICE:** Handle components and cards by their edges, and avoid touching pins and contacts. Ground yourself by touching a metal connector on the back of the computer. Continue to ground yourself periodically during this procedure.
- 7 Turn the computer over.
 - 8 Loosen the captive screw from the Mini PCI card/modem cover, and remove the cover.

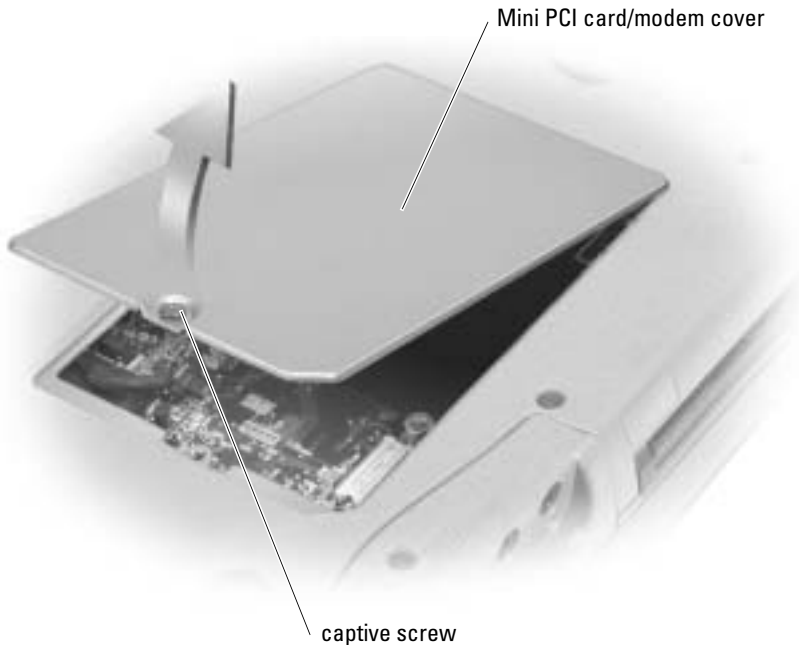

- 9 If a Mini PCI card is not already installed, go to step 10. If you are replacing a Mini PCI card, remove the existing card:
- a Disconnect the Mini PCI card from any attached cables.
 - b Release the Mini PCI card by spreading the metal securing tabs until the card pops up slightly.
 - c Lift the Mini PCI card out of its connector.

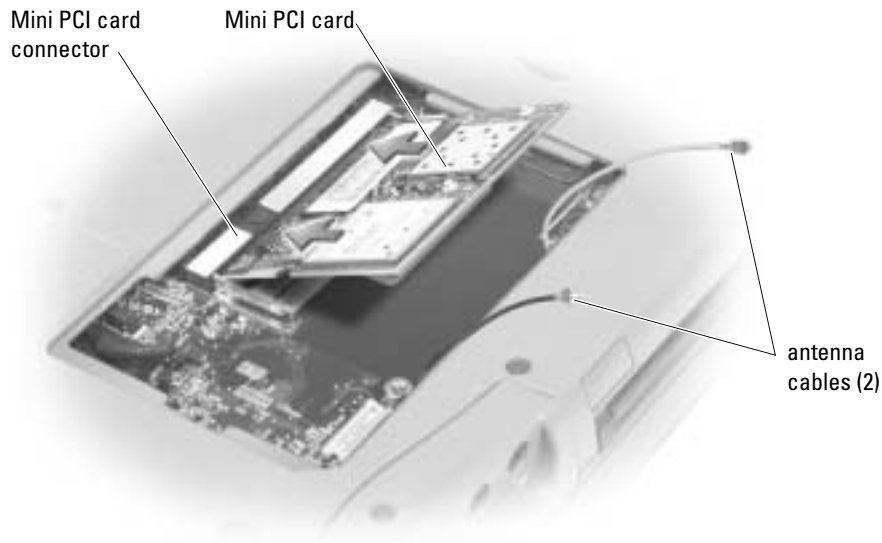

- ➡ **NOTICE:** To avoid damaging the Mini PCI card, never place cables on top of or under the card.
- ➡ **NOTICE:** The connectors are keyed to ensure correct insertion. If you feel resistance, check the connectors and realign the card.
- 10 Align the Mini PCI card with the connector at a 45-degree angle, and press the Mini PCI card into the connector until you feel a click.

- 11 Connect the antenna cables to the Mini PCI.

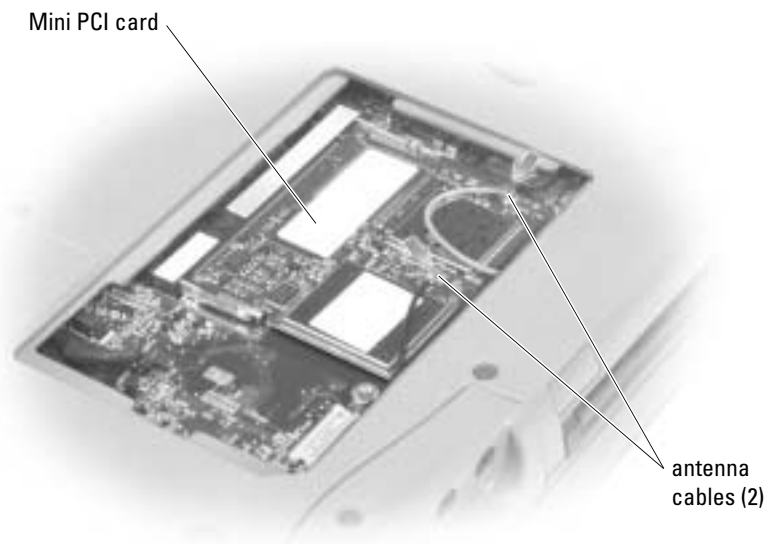

- 12 Replace the cover and tighten the screw.

Adding a Modem

If you ordered the optional modem at the same time that you ordered your computer, Dell installed the modem for you.

CAUTION: Before working inside your computer, read the safety instructions located in the *Product Information Guide*.

NOTICE: Handle components and cards by their edges, and avoid touching pins and contacts.

- 1 Ensure that the work surface is flat and clean to prevent scratching the computer cover.
- 2 Save and close any open files, exit any open programs, and shut down the computer (see page 26).
- 3 If the computer is docked, undock it.
- 4 Disconnect the computer from the electrical outlet.
- 5 Wait 10 to 20 seconds and then disconnect any attached devices.
- 6 Remove any installed PC Cards, batteries, and devices.
- 7 Ground yourself by touching a metal connector on the back of the computer, and continue to do so periodically during this procedure.

- 8 Turn the computer over, and loosen the captive screw from the Mini PCI card/modem cover.

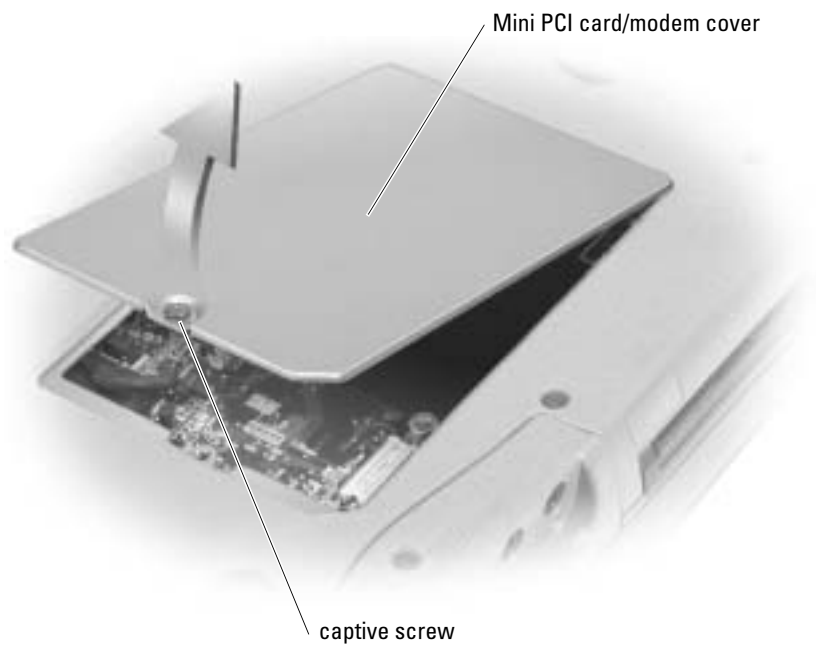

- 9** If a modem is not already installed, go to step 10. If you are replacing a modem, remove the existing modem:
- Remove the screws securing the modem to the system board, and set it aside.
 - Pull straight up on the attached pull-tab to lift the modem out of its connector on the system board, and disconnect the modem cable.

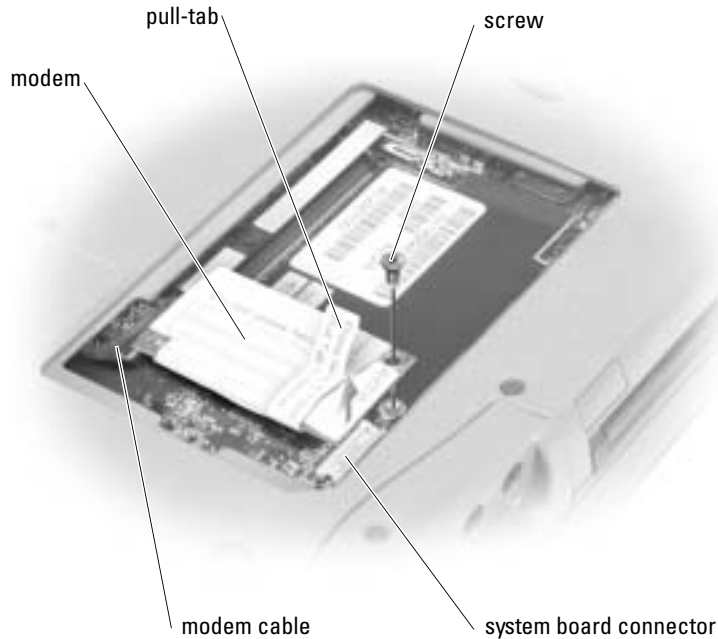

- 10** Connect the modem cable to the modem.
- NOTICE:** The cable connectors are keyed for correct insertion; do not force the connections.
- 11** Align the modem with the screw hole, and press the modem into the connector on the system board.
- 12** Install the screw to secure the modem to the system board.
- 13** Replace the Mini PCI card/modem cover.

Replacing the Hard Drive



CAUTION: If you remove the hard drive from the computer when the drive is hot, *do not touch* the metal housing of the hard drive.



CAUTION: Before working inside your computer, read the safety instructions located in the *Product Information Guide*.



NOTICE: To prevent data loss, turn off your computer (see page 26) before removing the hard drive. Do not remove the hard drive while the computer is on, in standby mode, or in hibernate mode.



NOTICE: Hard drives are extremely fragile; even a slight bump can damage the drive.



NOTE: Dell does not guarantee compatibility or provide support for hard drives from sources other than Dell.

To replace the hard drive in the hard drive bay:

- 1 Ensure that the work surface is flat and clean to prevent scratching the computer cover.
 - 2 Save and close any open files, exit any open programs, and then shut down the computer (see page 26).
 - 3 If the computer is connected to a docking device (docked), undock it. See the documentation that came with your docking device for instructions.
 - 4 Disconnect the computer from the electrical outlet.
 - 5 Wait 10 to 20 seconds, and then disconnect any attached devices.
 - 6 Remove any installed PC Cards, batteries, and module bay devices.
-  **NOTICE:** Handle components and cards by their edges, and avoid touching pins and contacts. Ground yourself by touching a metal connector on the back of the computer. Continue to ground yourself periodically during this procedure.

- 7 Turn the computer over, and remove the hard drive screw.



- 8 **NOTICE:** When the hard drive is not in the computer, store it in protective antistatic packaging.
- 8 Slide the hard drive out of the computer.
- 9 Remove the new drive from its packaging.
Save the original packaging for storing or shipping the hard drive.
- 9 **NOTICE:** Use firm and even pressure to slide the drive into place. If you use excessive force, you may damage the connector.
- 10 Slide the hard drive into the bay until it is fully seated.
- 11 Replace and tighten the screw.
- 12 Install the operating system for your computer.
- 13 Install the drivers and utilities for your computer.

Appendix

Specifications

Microprocessor

Microprocessor type	Intel® Mobile Pentium® M
L1 cache	32 KB (internal)
L2 cache	
1.3 GHz to 1.7 GHz	1 MB
1.8 GHz and above	2 MB
External bus frequency	400 MHz

System Information

System chip set	Intel 855PM
Data bus width	64 bits
DRAM bus width	64 bits
Microprocessor address bus width	32 bits

PC Card

CardBus controller	TI 4510 CardBus controller
PC Card connector	supports one Type I or Type II card
Cards supported	3.3 V and 5 V
PC Card connector size	68 pins
Data width (maximum)	PCMCIA 16 bits CardBus 32 bits

Memory

Memory module connector	two user-accessible SODIMM sockets
Memory module capacities	256 MB, 512 MB, and 1024 MB
Memory type	333-MHz DDR SDRAM (PC2700)
Standard memory	256 MB
Maximum memory	2 GB

Ports and Connectors

Video	15-hole connector
Audio	microphone miniconnector, stereo headphones/speakers miniconnector
USB	two 4-pin USB 2.0-compliant connectors
S-video TV-out	7-pin mini-DIN connector for S-video and composite video
Mini PCI	Type IIIA Mini PCI card slot
Modem	RJ-11 port
Network adapter	RJ-45 port

Communications

Modem:	
Type	v.92 56K MDC
Controller	softmodem
Interface	internal AC'97 bus
Network adapter	10/100 Ethernet LAN on system board
Wireless	Internal Mini PCI Wi-Fi and Bluetooth® wireless support (optional)

Video

Video type	32-bit hardware accelerated (NVIDIA GeForce FX Go 5200), 64-bit hardware accelerated (NVIDIA GeForce FX Go 5200 and ATI Mobility Radeon 9000) or, 128-bit hardware accelerated (NVIDIA GeForce4 4200 Go, NVIDIA GeForce FX Go5650, or ATI Mobility Radeon 9600)
Data bus	4X AGP
Video controller	ATI Mobility Radeon 9000, ATI Mobility Radeon 9600, NVIDIA GeForce4 4200 Go, NVIDIA GeForce FX Go 5200, or NVIDIA GeForce FX Go5650
Video memory	32 MB (ATI Mobility Radeon 9000 and NVIDIA GeForce FX Go 5200), 64MB (NVIDIA GeForce FX Go 5200 and NVIDIA GeForce4 4200 Go) or, 128 MB (ATI Mobility Radeon 9600 and NVIDIA GeForce FX Go5650)
LCD interface	LVDS
TV support	NTSC or PAL in S-video and composite modes

Audio

Audio type	Intel AC'97
Stereo conversion	20-bit (stereo digital-to-analog), 18-bit (stereo analog-to-digital)
Interfaces:	
Internal	AC'97
External	microphone miniconnector, stereo headphones/speakers miniconnector
Speaker	two 4-ohm speakers
Internal speaker amplifier	2-W channel into 4 ohms
Volume controls	keyboard shortcuts or program menus

Display

Type (active-matrix TFT)	WUXGA, WSXGA+, and WXGA
Dimensions:	
Height	222.5 mm (8.76 inches)
Width	344.5 mm (13.56 inches)
Diagonal	391.2 mm (15.4 inches)
Maximum resolutions	1920 x 1200 (WUXGA) 1680 x 1050 (WSXGA+) 1280 x 800 (WXGA)
Response time (typical)	35-ms fall (maximum)
Refresh rate	60 Hz
Operating angle	0° (closed) to 180°
Viewing angles:	
Horizontal	±65°
Vertical	±50°
Pixel pitch	0.1725 (WUXGA) 0.1971 (WSXGA+) 0.2588 (WXGA)
Power Consumption:	
Panel with backlight (typical)	5.5 W
Controls	brightness can be controlled through keyboard shortcuts

Keyboard

Number of keys	87 (U.S. and Canada); 88 (Europe); 91 (Japan)
Key travel	2.7 mm ± 0.3 mm (0.11 inch ± 0.016 inch)
Key spacing	19.05 mm ± 0.3 mm (0.75 inch ± 0.012 inch)
Layout	QWERTY/AZERTY/Kanji

Touch Pad

X/Y position resolution (graphics table mode)	240 cpi
Size:	
Width	64.88-mm (2.55-inch) sensor-active area
Height	48.88-mm (1.92-inch) rectangle

Battery

Type	9-cell "smart" lithium ion (72 WHr)
Dimensions:	
Depth	222.8 mm (8.77 inches)
Height	22.5 mm (0.89 inch)
Width	67 mm (2.64 inches)
Weight	0.48 kg (1.06 lb)
Voltage	11.1 VDC
Charge time with computer off	approximately 1.75 hours to reach 80 percent charge
Operating time	approximately 3 to 4 hours; can be significantly reduced under certain power-intensive conditions
Life span (approximate)	300 discharge/charge cycles
Temperature range:	
Operating	0° to 35°C (32° to 95°F)
Storage	-40° to 65°C (-40° to 149°F)

AC Adapter

Input voltage	90–264 VAC
Input current (maximum)	1.7 A
Input frequency	47–63 Hz
Output current	3.34 A (continuous) (65 W) 4.62 A (continuous) (90 W)
Output power	65 W (standard) or 90 W
Rated output voltage	19.5 VDC
Dimensions:	
Height	28.2 mm (1.11 inches) (65 W) 27.94 mm (1.1 inches) (90 W)
Width	57.9 mm (2.28 inches) (65 W) 58.42 mm (2.3 inches) (90 W)
Depth	137.2 mm (5.40 inches) (65 W) 133.85 mm (5.25 inches) (90 W)
Weight (with cables)	0.34 kg (0.7 lb) (65 W) 0.4 kg (0.9 lb) (90 W)
Temperature range:	
Operating	0° to 35°C (32° to 95°F)
Storage	–40° to 65°C (–40° to 149°F)

Physical

Height	38 mm (1.5 inches)
Width	359 mm (14.1 inches)
Depth	274 mm (10.8 inches)
Weight:	
With travel module and 72-WHr battery	3.13 kg (6.9 lb)
With CD drive and 72-WHr battery	3.27 kg (7.2 lb)

Environmental

Temperature range:

Operating	0° to 35°C (32° to 95°F)
Storage	-40° to 65°C (-40° to 149°F)

Relative humidity (maximum):

Operating	10% to 90% (noncondensing)
Storage	5% to 95% (noncondensing)

Maximum vibration (using a random-vibration spectrum that simulates user environment):

Operating	0.66 GRMS
Storage	1.30 GRMS

Maximum shock (measured with hard drive in head-parked position and a 2-ms half-sine pulse):

Operating	122 G
Storage	163 G

Altitude (maximum):

Operating	-15.2 to 3048 m (-50 to 10,000 ft)
Storage	-15.2 to 10,668 m (-50 to 35,000 ft)

Standard Settings

Overview

You can use the system setup program as follows:

- To set or change user-selectable features—for example, your computer password.
- To verify information about the computer's current configuration, such as the amount of system memory.

After you set up the computer, run the system setup program to familiarize yourself with you system configuration information and optional settings. You may want to write down the information for future reference.

 **NOTE:** Your operating system may automatically configure most of the options available in the system setup program, thus overriding options that you set through the system setup program. (An exception is the **External Hot Key** option, which you can disable or enable only through the system setup program.) For more information on configuring features for your operating system, see the Windows Help and Support Center.

The system setup screens display the current setup information and settings for your computer, such as:

- System configuration
- Boot order
- Boot (start-up) configuration and docking-device configuration settings
- Basic device configuration settings
- System security and hard-drive password settings

 **NOTICE:** Unless you are an expert computer user or are directed to do so by Dell technical support, do not change the settings for the system setup program. Certain changes might make your computer work incorrectly.

Viewing the System Setup Screens

- 1 Turn on (or restart) your computer.
- 2 When the DELL™ logo appears, press <F2> immediately. If you wait too long and the Windows logo appears, continue to wait until you see the Windows desktop. Then shut down your computer and try again.

System Setup Screens

On each screen, the system setup options are listed at the left. To the right of each option is the setting or value for that option. You can change settings that appear as white type on the screen. Options or values that you cannot change (because they are determined by the computer) appear less bright.

The upper-right corner of the screen displays help information for the currently highlighted option; the lower-right corner displays information about the computer. System setup key functions are listed across the bottom of the screen.

Commonly Used Options

Certain options require that you reboot the computer for new settings to take effect.

Changing the Boot Sequence

The *boot sequence*, or *boot order*, tells the computer where to look to find the software needed to start the operating system. You can control the boot sequence and enable/disable devices using the **Boot Order** page of the system setup program.

 **NOTE:** To change the boot sequence on a one-time-only basis, see page 97.

The **Boot Order** page displays a general list of the bootable devices that may be installed in your computer, including but not limited to the following:

- Diskette Drive
- Modular bay HDD
- Internal HDD
- CD/DVD/CD-RW drive

During the boot routine, the computer starts at the top of the list and scans each enabled device for the operating system start-up files. When the computer finds the files, it stops searching and starts the operating system.

To control the boot devices, select (highlight) a device by pressing the up arrow key or the down arrow key, and then enable or disable the device or change its order in the list.

- To enable or disable a device, highlight the item and press the spacebar. Enabled items appear as white and display a small triangle to the left; disabled items appear blue or dimmed without a triangle.
- To reorder a device in the list, highlight the device and then press <u> or <d> (not case-sensitive) to move the highlighted device up or down.

Boot sequence changes take effect as soon as you save the changes and exit the system setup program.

Performing a One-Time Boot

You can set a one-time-only boot sequence without entering the system setup program. (You can also use this procedure to boot the Dell Diagnostics on the diagnostics utility partition on your hard drive.)

- 1** Turn off the computer.
- 2** If the computer is connected to a docking device (docked), undock it. See the documentation that came with your docking device for instructions.
- 3** Connect the computer to an electrical outlet.
- 4** Turn on the computer. When the DELL logo appears, press <F12> immediately. If you wait too long and the Windows logo appears, continue to wait until you see the Windows desktop. Then shut down your computer and try again.
- 5** When the boot device list appears, highlight the device from which you want to boot and press <Enter>.

The computer boots to the selected device.

The next time you reboot the computer, the previous boot order is restored.

Changing Printer Modes

 **NOTE:** Changing this setting only takes effect if your computer is connected to a docking station.

Set the **Parallel Mode** option according to the type of printer or device connected to the parallel connector. To determine the correct mode to use, see the documentation that came with the device.

Setting **Parallel Mode** to **Disabled** disables the parallel port and the port's LPT address, freeing computer resources for another device to use.

Changing COM Ports

 **NOTE:** Changing this setting only takes effect if your computer is connected to a docking station.

Serial Port allows you to map the serial port COM address or disable the serial port and its address, freeing computer resources for another device to use.

Dell Technical Support Policy (U.S. Only)

Technician-assisted technical support requires the cooperation and participation of the customer in the troubleshooting process and provides for restoration of the operating system, application software, and hardware drivers to the original default configuration as shipped from Dell, as well as the verification of appropriate functionality of the computer and all Dell-installed hardware. In addition to this technician-assisted technical support, online technical support is available at support.dell.com. Additional technical support options may be available for purchase.

Dell provides limited technical support for the computer and any "Dell-installed" software and peripherals¹. Support for third-party software and peripherals is provided by the original manufacturer, including those purchased and/or installed through Dell Software and Peripherals, Readyware, and Custom Factory Integration².

¹ Repair services are provided pursuant to the terms and conditions of your limited warranty and any optional support service contract purchased with the computer.

² All Dell-standard components included in a Custom Factory Integration (CFI) project are covered by the standard Dell limited warranty for your computer. However, Dell also extends a parts replacement program to cover all nonstandard, third-party hardware components integrated through CFI for the duration of the computer's service contract.

Definition of "Dell-Installed" Software and Peripherals

Dell-installed software includes the operating system and some of the application software that is preinstalled on the computer during the manufacturing process (Microsoft Office, Norton Antivirus, and so on).

Dell-installed peripherals include any internal expansion cards, or Dell-branded module bay or PC Card accessories. In addition, any Dell-branded monitors, keyboards, mice, speakers, microphones for telephonic modems, docking stations/port replicators, networking products, and all associated cabling are included.

Definition of "Third-Party" Software and Peripherals

Third-party software and peripherals include any peripheral, accessory, or application software sold by Dell not under the Dell brand (printers, scanners, cameras, games, and so on). Support for all third-party software and peripherals is provided by the original manufacturer of the product.

FCC Notices (U.S. Only)

Most Dell computer systems are classified by the Federal Communications Commission (FCC) as Class B digital devices. To determine which classification applies to your computer system, examine all FCC registration labels located on the bottom, side, or back panel of your computer, on card-mounting brackets, and on the cards themselves. If any one of the labels carries a Class A rating, your entire system is considered to be a Class A digital device. If *all* labels carry an FCC Class B rating as distinguished by either an FCC ID number or the FCC logo, (FCC), your system is considered to be a Class B digital device.

Once you have determined your system's FCC classification, read the appropriate FCC notice. Note that FCC regulations provide that changes or modifications not expressly approved by Dell could void your authority to operate this equipment.

This device complies with Part 15 of the FCC Rules. Operation is subject to the following two conditions:

- This device may not cause harmful interference.
- This device must accept any interference received, including interference that may cause undesired operation.

Class A

This equipment has been tested and found to comply with the limits for a Class A digital device pursuant to Part 15 of the FCC Rules. These limits are designed to provide reasonable protection against harmful interference when the equipment is operated in a commercial environment. This equipment generates, uses, and can radiate radio frequency energy and, if not installed and used in accordance with the manufacturer's instruction manual, may cause harmful interference with radio communications. Operation of this equipment in a residential area is likely to cause harmful interference, in which case you will be required to correct the interference at your own expense.

Class B

This equipment has been tested and found to comply with the limits for a Class B digital device pursuant to Part 15 of the FCC Rules. These limits are designed to provide reasonable protection against harmful interference in a residential installation. This equipment generates, uses, and can radiate radio frequency energy and, if not installed and used in accordance with the manufacturer's instruction manual, may cause interference with radio communications. However, there is no guarantee that interference will not occur in a particular installation. If this equipment does cause

harmful interference to radio or television reception, which can be determined by turning the equipment off and on, you are encouraged to try to correct the interference by one or more of the following measures:

- Reorient or relocate the receiving antenna.
- Increase the separation between the equipment and the receiver.
- Connect the equipment into an outlet on a circuit different from that to which the receiver is connected.
- Consult the dealer or an experienced radio/television technician for help.

FCC Identification Information

The following information is provided on the device or devices covered in this document in compliance with FCC regulations:

- Model number: PP02X
- Company name:

Dell Inc.
One Dell Way
Round Rock, Texas 78682 USA
512-338-4400

Contacting Dell

To contact Dell electronically, you can access the following websites:

- www.dell.com
- support.dell.com (technical support)
- premiersupport.dell.com (technical support for educational, government, healthcare, and medium/large business customers, including Premier, Platinum, and Gold customers)

For specific web addresses for your country, find the appropriate country section in the table below.

NOTE: Toll-free numbers are for use within the country for which they are listed.

When you need to contact Dell, use the electronic addresses, telephone numbers, and codes provided in the following table. If you need assistance in determining which codes to use, contact a local or an international operator.

Country (City) International Access Code Country Code City Code	Department Name or Service Area, Website and E-Mail Address	Area Codes, Local Numbers, and Toll-Free Numbers
Anguilla	General Support	toll-free: 800-335-0031
Antigua and Barbuda	General Support	1-800-805-5924
Argentina (Buenos Aires)	Website: www.dell.com.ar	
International Access Code: 00	E-mail: us_latin_services@dell.com	
Country Code: 54	E-mail for desktop and portable computers: la-techsupport@dell.com	
City Code: 11	E-mail for servers and EMC: la_enterprise@dell.com	
	Customer Care	toll-free: 0-800-444-0730
	Tech Support	toll-free: 0-800-444-0733
	Tech Support Services	toll-free: 0-800-444-0724
	Sales	0-810-444-3355
Aruba	General Support	toll-free: 800-1578
Australia (Sydney)	E-mail (Australia): au_tech_support@dell.com	
International Access Code: 0011	E-mail (New Zealand): nz_tech_support@dell.com	
Country Code: 61	Home and Small Business	1-300-655-533
City Code: 2	Government and Business	toll-free: 1-800-633-559
	Preferred Accounts Division (PAD)	toll-free: 1-800-060-889
	Customer Care	toll-free: 1-800-819-339
	Technical Support (portables and desktops)	toll-free: 1-300-655-533
	Technical Support (servers and workstations)	toll-free: 1-800-733-314
	Corporate Sales	toll-free: 1-800-808-385
	Transaction Sales	toll-free: 1-800-808-312
	Fax	toll-free: 1-800-818-341

Country (City) International Access Code Country Code City Code	Department Name or Service Area, Website and E-Mail Address	Area Codes, Local Numbers, and Toll-Free Numbers
Austria (Vienna)	Website: support.euro.dell.com	
International Access Code: 900	E-mail: tech_support_central_europe@dell.com	
Country Code: 43	Home/Small Business Sales	0820 240 530 00
City Code: 1	Home/Small Business Fax	0820 240 530 49
	Home/Small Business Customer Care	0820 240 530 14
	Preferred Accounts/Corporate Customer Care	0820 240 530 16
	Home/Small Business Technical Support	0820 240 530 14
	Preferred Accounts/Corporate Technical Support	0660 8779
	Switchboard	0820 240 530 00
Bahamas	General Support	toll-free: 1-866-278-6818
Barbados	General Support	1-800-534-3066
Belgium (Brussels)	Website: support.euro.dell.com	
International Access Code: 00	E-mail for French-speaking Customers: support.euro.dell.com/be/fr/emailldell/	
Country Code: 32	Technical Support	02 481 92 88
City Code: 2	Technical Support Fax	02 481 92 95
	Customer Care	02 713 15 .65
	Corporate Sales	02 481 91 00
	Fax	02 481 92 99
	Switchboard	02 481 91 00
Bermuda	General Support	1-800-342-0671
Bolivia	General Support	toll-free: 800-10-0238
Brazil	Website: www.dell.com/br	
International Access Code: 00	Customer Support, Technical Support	0800 90 3355
Country Code: 55	Technical Support Fax	51 481 5470
City Code: 51	Customer Care Fax	51 481 5480
	Sales	0800 90 3390
British Virgin Islands	General Support	toll-free: 1-866-278-6820
Brunei	Customer Technical Support (Penang, Malaysia)	604 633 4966
Country Code: 673	Customer Service (Penang, Malaysia)	604 633 4949
	Transaction Sales (Penang, Malaysia)	604 633 4955

Country (City) International Access Code Country Code City Code	Department Name or Service Area, Website and E-Mail Address	Area Codes, Local Numbers, and Toll-Free Numbers
Canada (North York, Ontario) International Access Code: 011	Online Order Status: www.dell.ca/ostatus AutoTech (automated technical support) Customer Care (Home Sales/Small Business) Customer Care (med./large business, government) Technical Support (Home Sales/Small Business) Technical Support (med./large bus., government) Sales (Home Sales/Small Business) Sales (med./large bus., government) Spare Parts Sales & Extended Service Sales	toll-free: 1-800-247-9362 toll-free: 1-800-847-4096 toll-free: 1-800-326-9463 toll-free: 1-800-847-4096 toll-free: 1-800-387-5757 toll-free: 1-800-387-5752 toll-free: 1-800-387-5755 1 866 440 3355
Cayman Islands	General Support	1-800-805-7541
Chile (Santiago) Country Code: 56 City Code: 2	Sales, Customer Support, and Technical Support	toll-free: 1230-020-4823

Country (City) International Access Code Country Code City Code	Department Name or Service Area, Website and E-Mail Address	Area Codes, Local Numbers, and Toll-Free Numbers
China (Xiamen) Country Code: 86 City Code: 592	Technical Support website: support.dell.com.cn Technical Support E-mail: cn_support@dell.com Customer Care E-mail: customer_cn@dell.com Technical Support Fax Technical Support (Dell™ Dimension™ and Inspiron™) Technical Support (OptiPlex™, Latitude™, and Dell Precision™) Technical Support (servers and storage) Technical Support (projectors, PDAs, switches, routers, and so on) Technical Support (printers) Customer Care Customer Care Fax Home and Small Business Preferred Accounts Division Large Corporate Accounts GCP Large Corporate Accounts Key Accounts Large Corporate Accounts North Large Corporate Accounts North Government and Education Large Corporate Accounts East Large Corporate Accounts East Government and Education Large Corporate Accounts Queue Team Large Corporate Accounts South Large Corporate Accounts West Large Corporate Accounts Spare Parts	592 818 1350 toll-free: 800 858 2969 toll-free: 800 858 0950 toll-free: 800 858 0960 toll-free: 800 858 2920 toll-free: 800 858 2311 toll-free: 800 858 2060 592 818 1308 toll-free: 800 858 2222 toll-free: 800 858 2557 toll-free: 800 858 2055 toll-free: 800 858 2628 toll-free: 800 858 2999 toll-free: 800 858 2955 toll-free: 800 858 2020 toll-free: 800 858 2669 toll-free: 800 858 2572 toll-free: 800 858 2355 toll-free: 800 858 2811 toll-free: 800 858 2621
Colombia	General Support	980-9-15-3978
Costa Rica	General Support	0800-012-0435

Country (City) International Access Code Country Code City Code	Department Name or Service Area, Website and E-Mail Address	Area Codes, Local Numbers, and Toll-Free Numbers
Czech Republic (Prague)	Website: support.euro.dell.com	
International Access Code: 00	E-mail: czech_dell@dell.com	
Country Code: 420	Technical Support	22537 2727
	Customer Care	22537 2707
	Fax	22537 2714
	Tech Fax	22537 2728
	Switchboard	22537 2711
Denmark (Copenhagen)	Website: support.euro.dell.com	
International Access Code: 00	E-mail: support.euro.dell.com/dk/da/emaildell/	
Country Code: 45	Technical Support	7023 0182
	Customer Care (Relational)	7023 0184
	Home/Small Business Customer Care	3287 5505
	Switchboard (Relational)	3287 1200
	Switchboard Fax (Relational)	3287 1201
	Switchboard (Home/Small Business)	3287 5000
	Switchboard Fax (Home/Small Business)	3287 5001
Dominica	General Support	toll-free: 1-866-278-6821
Dominican Republic	General Support	1-800-148-0530
Ecuador	General Support	toll-free: 999-119
El Salvador	General Support	01-899-753-0777
Finland (Helsinki)	Website: support.euro.dell.com	
International Access Code: 990	E-mail: support.euro.dell.com/fi/fi/emaildell/	
Country Code: 358	Technical Support	09 253 313 60
City Code: 9	Customer Care	09 253 313 38
	Fax	09 253 313 99
	Switchboard	09 253 313 00

Country (City) International Access Code Country Code City Code	Department Name or Service Area, Website and E-Mail Address	Area Codes, Local Numbers, and Toll-Free Numbers
France (Paris) (Montpellier) International Access Code: 00 Country Code: 33 City Codes: (1) (4)	Website: support.euro.dell.com	
	E-mail: support.euro.dell.com/fr/fr/emaildell/	
	Home and Small Business	
	Technical Support	0825 387 270
	Customer Care	0825 823 833
	Switchboard	0825 004 700
	Switchboard (calls from outside of France)	04 99 75 40 00
	Sales	0825 004 700
	Fax	0825 004 701
	Fax (calls from outside of France)	04 99 75 40 01
	Corporate	
	Technical Support	0825 004 719
	Customer Care	0825 338 339
	Switchboard	01 55 94 71 00
	Sales	01 55 94 71 00
Fax	01 55 94 71 01	
Germany (Langen) International Access Code: 00 Country Code: 49 City Code: 6103	Website: support.euro.dell.com	
	E-mail: tech_support_central_europe@dell.com	
	Technical Support	06103 766-7200
	Home/Small Business Customer Care	0180-5-224400
	Global Segment Customer Care	06103 766-9570
	Preferred Accounts Customer Care	06103 766-9420
	Large Accounts Customer Care	06103 766-9560
	Public Accounts Customer Care	06103 766-9555
Switchboard	06103 766-7000	

Country (City) International Access Code Country Code City Code	Department Name or Service Area, Website and E-Mail Address	Area Codes, Local Numbers, and Toll-Free Numbers
Greece	Website: support.euro.dell.com	
International Access Code: 00	E-mail: support.euro.dell.com/gr/en/emaildell/	
Country Code: 30	Technical Support	00800-44 14 95 18
	Gold Service Technical Support	00800-44 14 00 83
	Switchboard	2108129810
	Gold Service Switchboard	2108129811
	Sales	2108129800
	Fax	2108129812
Grenada	General Support	toll-free: 1-866-540-3355
Guatemala	General Support	1-800-999-0136
Guyana	General Support	toll-free: 1-877-270-4609
Hong Kong	Website: support.ap.dell.com	
International Access Code: 001	Technical Support E-mail: apsupport@dell.com	
Country Code: 852	Technical Support (Dimension and Inspiron)	2969 3188
	Technical Support (OptiPlex, Latitude, and Dell Precision)	2969 3191
	Technical Support (PowerApp™, PowerEdge™, PowerConnect™, and PowerVault™)	2969 3196
	Customer Care	3416 0910
	Large Corporate Accounts	3416 0907
	Global Customer Programs	3416 0908
	Medium Business Division	3416 0912
	Home and Small Business Division	2969 3105
India	Technical Support	1600 33 8045
	Sales (Large Corporate Accounts)	1600 33 8044
	Sales (Home and Small Business)	1600 33 8046

Country (City) International Access Code Country Code City Code	Department Name or Service Area, Website and E-Mail Address	Area Codes, Local Numbers, and Toll-Free Numbers
Ireland (Cherrywood)	Website: support.euro.dell.com	
International Access Code: 16	E-mail: dell_direct_support@dell.com	
Country Code: 353	Technical Support	1850 543 543
City Code: 1	U.K. Technical Support (dial within U.K. only)	0870 908 0800
	Home User Customer Care	01 204 4014
	Small Business Customer Care	01 204 4014
	U.K. Customer Care (dial within U.K. only)	0870 906 0010
	Corporate Customer Care	1850 200 982
	Corporate Customer Care (dial within U.K. only)	0870 907 4499
	Ireland Sales	01 204 4444
	U.K. Sales (dial within U.K. only)	0870 907 4000
	Fax/Sales Fax	01 204 0103
	Switchboard	01 204 4444
Italy (Milan)	Website: support.euro.dell.com	
International Access Code: 00	E-mail: support.euro.dell.com/it/it/emaildell/	
Country Code: 39	Home and Small Business	
City Code: 02	Technical Support	02 577 826 90
	Customer Care	02 696 821 14
	Fax	02 696 821 13
	Switchboard	02 696 821 12
	Corporate	
	Technical Support	02 577 826 90
	Customer Care	02 577 825 55
	Fax	02 575 035 30
	Switchboard	02 577 821
Jamaica	General Support (dial from within Jamaica only)	1-800-682-3639

Country (City) International Access Code Country Code City Code	Department Name or Service Area, Website and E-Mail Address	Area Codes, Local Numbers, and Toll-Free Numbers
Japan (Kawasaki)	Website: support.jp.dell.com	
International Access Code: 001	Technical Support (servers)	toll-free: 0120-198-498
Country Code: 81	Technical Support outside of Japan (servers)	81-44-556-4162
City Code: 44	Technical Support (Dimension and Inspiron)	toll-free: 0120-198-226
	Technical Support outside of Japan (Dimension and Inspiron)	81-44-520-1435
	Technical Support (Dell Precision, OptiPlex, and Latitude)	toll-free:0120-198-433
	Technical Support outside of Japan (Dell Precision, OptiPlex, and Latitude)	81-44-556-3894
	Technical Support (PDAs, projectors, printers, routers)	toll-free: 0120-981-690
	Technical Support outside of Japan (PDAs, projectors, printers, routers)	81-44-556-3468
	Faxbox Service	044-556-3490
	24-Hour Automated Order Service	044-556-3801
	Customer Care	044-556-4240
	Business Sales Division (up to 400 employees)	044-556-1465
	Preferred Accounts Division Sales (over 400 employees)	044-556-3433
	Large Corporate Accounts Sales (over 3500 employees)	044-556-3430
	Public Sales (government agencies, educational institutions, and medical institutions)	044-556-1469
	Global Segment Japan	044-556-3469
	Individual User	044-556-1760
	Switchboard	044-556-4300
Korea (Seoul)	Technical Support	toll-free: 080-200-3800
International Access Code: 001	Sales	toll-free: 080-200-3600
Country Code: 82	Customer Service (Penang, Malaysia)	604 633 4949
City Code: 2	Fax	2194-6202
	Switchboard	2194-6000
	Technical Support (Electronics and Accessories)	toll-free: 080-200-3801

Country (City) International Access Code Country Code City Code	Department Name or Service Area, Website and E-Mail Address	Area Codes, Local Numbers, and Toll-Free Numbers
Latin America	Customer Technical Support (Austin, Texas, U.S.A.)	512 728-4093
	Customer Service (Austin, Texas, U.S.A.)	512 728-3619
	Fax (Technical Support and Customer Service) (Austin, Texas, U.S.A.)	512 728-3883
	Sales (Austin, Texas, U.S.A.)	512 728-4397
	SalesFax (Austin, Texas, U.S.A.)	512 728-4600 or 512 728-3772
Luxembourg	Website: support.euro.dell.com	
International Access Code: 00	E-mail: tech_be@dell.com	
Country Code: 352	Technical Support (Brussels, Belgium)	3420808075
	Home/Small Business Sales (Brussels, Belgium)	toll-free: 080016884
	Corporate Sales (Brussels, Belgium)	02 481 91 00
	Customer Care (Brussels, Belgium)	02 481 91 19
	Fax (Brussels, Belgium)	02 481 92 99
	Switchboard (Brussels, Belgium)	02 481 91 00
Macao	Technical Support	toll-free: 0800 105
Country Code: 853	Customer Service (Xiamen, China)	34 160 910
	Transaction Sales (Xiamen, China)	29 693 115
Malaysia (Penang)	Website: support.ap.dell.com	
International Access Code: 00	Technical Support (Dell Precision, OptiPlex, and Latitude)	toll-free: 1 800 88 0193
Country Code: 60	Technical Support (Dimension, Inspiron, and Electronics and Accessories)	toll-free: 1 800 88 1306
City Code: 4	Technical Support (PowerApp, PowerEdge, PowerConnect, and PowerVault)	toll-free: 1800 88 1386
	Customer Service (Penang, Malaysia)	04 633 4949
	Transaction Sales	toll-free: 1 800 888 202
	Corporate Sales	toll-free: 1 800 888 213

Country (City) International Access Code Country Code City Code	Department Name or Service Area, Website and E-Mail Address	Area Codes, Local Numbers, and Toll-Free Numbers
Mexico International Access Code: 00 Country Code: 52	Customer Technical Support Sales Customer Service Main	001-877-384-8979 or 001-877-269-3383 50-81-8800 or 01-800-888-3355 001-877-384-8979 or 001-877-269-3383 50-81-8800 or 01-800-888-3355
Montserrat	General Support	toll-free: 1-866-278-6822
Netherlands Antilles	General Support	001-800-882-1519
Netherlands (Amsterdam) International Access Code: 00 Country Code: 31 City Code: 20	Website: support.euro.dell.com Technical Support Technical Support Fax Home/Small Business Customer Care Relational Customer Care Home/Small Business Sales Relational Sales Home/Small Business Sales Fax Relational Sales Fax Switchboard Switchboard Fax	020 674 45 00 020 674 47 66 020 674 42 00 020 674 4325 020 674 55 00 020 674 50 00 020 674 47 75 020 674 47 50 020 674 50 00 020 674 47 50
New Zealand International Access Code: 00 Country Code: 64	E-mail (New Zealand): nz_tech_support@dell.com E-mail (Australia): au_tech_support@dell.com Technical Support (for desktop and portable computers) Technical Support (for servers and workstations) Home and Small Business Government and Business Sales Fax	toll-free: 0800 446 255 toll-free: 0800 443 563 0800 446 255 0800 444 617 0800 441 567 0800 441 566
Nicaragua	General Support	001-800-220-1006

Country (City) International Access Code Country Code City Code	Department Name or Service Area, Website and E-Mail Address	Area Codes, Local Numbers, and Toll-Free Numbers
Norway (Lysaker)	Website: support.euro.dell.com	
International Access Code: 00	E-mail: support.euro.dell.com/no/no/emaildell/	
Country Code: 47	Technical Support	671 16882
	Relational Customer Care	671 17575
	Home/Small Business Customer Care	23162298
	Switchboard	671 16800
	Fax Switchboard	671 16865
Panama	General Support	001-800-507-0962
Peru	General Support	0800-50-669
Poland (Warsaw)	Website: support.euro.dell.com	
International Access Code: 011	E-mail: pl_support_tech@dell.com	
Country Code: 48	Customer Service Phone	57 95 700
City Code: 22	Customer Care	57 95 999
	Sales	57 95 999
	Customer Service Fax	57 95 806
	Reception Desk Fax	57 95 998
	Switchboard	57 95 999
Portugal	Website: support.euro.dell.com	
International Access Code: 00	E-mail: support.euro.dell.com/pt/en/emaildell/	
Country Code: 351	Technical Support	707200149
	Customer Care	800 300 413
	Sales	800 300 410 or 800 300 411 or 800 300 412 or 21 422 07 10
	Fax	21 424 01 12
Puerto Rico	General Support	1-800-805-7545
St. Kitts and Nevis	General Support	toll-free: 1-877-441-4731
St. Lucia	General Support	1-800-882-1521
St. Vincent and the Grenadines	General Support	toll-free: 1-877-270-4609

Country (City) International Access Code Country Code City Code	Department Name or Service Area, Website and E-Mail Address	Area Codes, Local Numbers, and Toll-Free Numbers
Singapore (Singapore)	Website: support.ap.dell.com	
International Access Code: 005 Country Code: 65	Technical Support (Dimension, Inspiron, and Electronics and Accessories)	toll-free: 1800 394 7430
	Technical Support (OptiPlex, Latitude, and Dell Precision)	toll-free: 1800 394 7488
	Technical Support (PowerApp, PowerEdge, PowerConnect, and PowerVault)	toll-free: 1800 394 7478
	Customer Service (Penang, Malaysia)	604 633 4949
	Transaction Sales	toll-free: 1 800 394 7412
	Corporate Sales	toll-free: 1 800 394 7419
Slovakia (Prague)	Website: support.euro.dell.com	
International Access Code: 00 Country Code: 421	E-mail: czech_dell@dell.com	
	Technical Support	02 5441 5727
	Customer Care	420 22537 2707
	Fax	02 5441 8328
	Tech Fax	02 5441 8328
	Switchboard (Sales)	02 5441 7585
South Africa (Johannesburg)	Website: support.euro.dell.com	
International Access Code: 09/091 Country Code: 27 City Code: 11	E-mail: dell_za_support@dell.com	
	Gold Queue	011 709 7713
	Technical Support	011 709 7710
	Customer Care	011 709 7707
	Sales	011 709 7700
	Fax	011 706 0495
	Switchboard	011 709 7700
Southeast Asian and Pacific Countries	Customer Technical Support, Customer Service, and Sales (Penang, Malaysia)	604 633 4810

Country (City) International Access Code Country Code City Code	Department Name or Service Area, Website and E-Mail Address	Area Codes, Local Numbers, and Toll-Free Numbers
Spain (Madrid)	Website: support.euro.dell.com	
International Access Code: 00	E-mail: support.euro.dell.com/es/es/emaildell/	
Country Code: 34	Home and Small Business	
City Code: 91	Technical Support	902 100 130
	Customer Care	902 118 540
	Sales	902 118 541
	Switchboard	902 118 541
	Fax	902 118 539
	Corporate	
	Technical Support	902 100 130
	Customer Care	902 115 236
	Switchboard	91 722 92 00
	Fax	91 722 95 83
Sweden (Upplands Vasby)	Website: support.euro.dell.com	
International Access Code: 00	E-mail: support.euro.dell.com/se/sv/emaildell/	
Country Code: 46	Technical Support	08 590 05 199
City Code: 8	Relational Customer Care	08 590 05 642
	Home/Small Business Customer Care	08 587 70 527
	Employee Purchase Program (EPP) Support	20 140 14 44
	Technical Support Fax	08 590 05 594
	Sales	08 590 05 185
Switzerland (Geneva)	Website: support.euro.dell.com	
International Access Code: 00	E-mail: Tech_support_central_Europe@dell.com	
Country Code: 41	E-mail for French-speaking HSB and Corporate Customers: support.euro.dell.com/ch/fr/emaildell/	
City Code: 22	Technical Support (Home and Small Business)	0844 811 411
	Technical Support (Corporate)	0844 822 844
	Customer Care (Home and Small Business)	0848 802 202
	Customer Care (Corporate)	0848 821 721
	Fax	022 799 01 90
	Switchboard	022 799 01 01

Country (City) International Access Code Country Code City Code	Department Name or Service Area, Website and E-Mail Address	Area Codes, Local Numbers, and Toll-Free Numbers
Taiwan	Website: support.ap.dell.com	
International Access Code: 002	E-mail: ap_support@dell.com	
Country Code: 886	Technical Support (OptiPlex, Latitude, Inspiron, Dimension, and Electronics and Accessories)	toll-free: 00801 86 1011
	Technical Support (PowerApp, PowerEdge, PowerConnect, and PowerVault)	toll-free: 00801 60 1256
	Transaction Sales	toll-free: 00801 65 1228
	Corporate Sales	toll-free: 00801 651 227
Thailand	Website: support.ap.dell.com	
International Access Code: 001	Technical Support (OptiPlex, Latitude, and Dell Precision)	toll-free: 1800 0060 07
Country Code: 66	Technical Support (PowerApp, PowerEdge, PowerConnect, and PowerVault)	toll-free: 1800 0600 09
	Customer Service (Penang, Malaysia)	604 633 4949
	Corporate Sales	toll-free: 1800 006 009
	Transaction Sales	toll-free: 1800 006 006
Trinidad/Tobago	General Support	1-800-805-8035
Turks and Caicos Islands	General Support	toll-free: 1-866-540-3355

Country (City) International Access Code Country Code City Code	Department Name or Service Area, Website and E-Mail Address	Area Codes, Local Numbers, and Toll-Free Numbers
U.K. (Bracknell)	Website: support.euro.dell.com	
International Access Code: 00	Customer Care website: support.euro.dell.com/uk/en/ECare/Form/Home.asp	
Country Code: 44		
City Code: 1344	E-mail: dell_direct_support@dell.com	
	Technical Support (Corporate/Preferred Accounts/PAD [1000+ employees])	0870 908 0500
	Technical Support (direct and general)	0870 908 0800
	Global Accounts Customer Care	01344 373 186
	Home and Small Business Customer Care	0870 906 0010
	Corporate Customer Care	01344 373 185
	Preferred Accounts (500–5000 employees) Customer Care	0870 906 0010
	Central Government Customer Care	01344 373 193
	Local Government & Education Customer Care	01344 373 199
	Health Customer Care	01344 373 194
	Home and Small Business Sales	0870 907 4000
	Corporate/Public Sector Sales	01344 860 456
	Home and Small Business Fax	0870 907 4006
Uruguay	General Support	toll-free: 000-413-598-2521

Country (City) International Access Code Country Code City Code	Department Name or Service Area, Website and E-Mail Address	Area Codes, Local Numbers, and Toll-Free Numbers
U.S.A. (Austin, Texas)	Automated Order-Status Service	toll-free: 1-800-433-9014
International Access Code: 011 Country Code: 1	AutoTech (portable and desktop computers) Consumer (Home and Home Office) Technical Support Customer Service DellNet™ Service and Support Employee Purchase Program (EPP) Customers Financial Services website: www.dellfinancialservices.com Financial Services (lease/loans) Financial Services (Dell Preferred Accounts [DPA]) Business Customer Service and Technical Support Employee Purchase Program (EPP) Customers Printers and Projectors Technical Support Public (government, education, and healthcare) Customer Service and Technical Support Employee Purchase Program (EPP) Customers Dell Sales Dell Outlet Store (Dell refurbished computers) Software and Peripherals Sales Spare Parts Sales Extended Service and Warranty Sales Fax Dell Services for the Deaf, Hard-of-Hearing, or Speech-Impaired	toll-free: 1-800-247-9362 toll-free: 1-800-624-9896 toll-free: 1-800-624-9897 toll-free: 1-877-Dellnet (1-877-335-5638) toll-free: 1-800-695-8133 toll-free: 1-877-577-3355 toll-free: 1-800-283-2210 toll-free: 1-800-822-8965 toll-free: 1-800-695-8133 toll-free: 1-877-459-7298 toll-free: 1-800-456-3355 toll-free: 1-800-234-1490 toll-free: 1-800-289-3355 or toll-free: 1-800-879-3355 toll-free: 1-888-798-7561 toll-free: 1-800-671-3355 toll-free: 1-800-357-3355 toll-free: 1-800-247-4618 toll-free: 1-800-727-8320 toll-free: 1-877-DELLTTY (1-877-335-5889)
U.S. Virgin Islands	General Support	1-877-673-3355
Venezuela	General Support	8001-3605

Index

A

- air vents
 - description, 19
 - system view, 19
- audio connectors
 - description, 15
 - system view, 15
- audio device
 - connecting, 47

B

- battery
 - charge gauge, 29
 - charging, 29
 - checking the charge, 28
 - description, 20
 - health gauge, 29
 - installing, 30
 - low-battery warning, 29
 - performance, 27
 - power meter, 29
 - removing, 30
 - storing, 31
 - system view, 20

C

- CDs, 45
- characters
 - unexpected, 44

- computer
 - crashes, 66
 - restore to previous state, 71
 - specifications, 89
- conflicts
 - drivers, 70
 - resolving software and hardware incompatibilities, 74
- connecting
 - audio device, 47
 - TV, 47

Connecting to a Wireless Local Area Network, 54

- copying CDs
 - general information, 45
 - helpful tips, 46
 - how to copy a CD, 45
- crashes, 66

D

- damaged computer
 - testing, 68
- Dell
 - support site, 10
- Dell support policy, 98
- Device Driver Rollback, 70
- device latch release
 - description, 17
 - system view, 17

- device status lights
 - description, 12
- display
 - description, 11
 - system view, 11
- display latch
 - description, 11
 - system view, 11
- display latch button
 - description, 13
 - system view, 13
- docking device latch
 - description, 20
 - system view, 20
- documentation
 - help file, 9
 - online, 10
 - Setup Diagram, 9
- drivers
 - definition, 69
 - reinstalling, 70
 - troubleshooting, 70
- drives
 - fixing problems, 64
 - See hard drive, 87
- DVDs, 45

E

- e-mail
 - fixing problems, 67

F

- fan
 - description, 20
 - system view, 20
- Finding Information, 9
- finding solutions, 59
- floppy drive
 - fixing problems, 64

H

- hard drive
 - description, 16, 20
 - replacing, 87
 - system view, 16, 20
- hardware
 - drivers, 69
- Hardware Troubleshooter, 74
- Help and Support Center, 10
- help file, 9
 - accessing, 61

I

- IEEE 1394 connector
 - description, 15
 - system view, 15
- Internet connection
 - about, 21
 - options, 21
 - setting up, 21
- IRQ conflicts, 74

K

- keyboard
 - description, 13
 - fixing problems, 44
 - shortcuts, 40
 - system view, 13
 - unexpected characters, 44
- keyboard status lights
 - description, 14
 - system view, 14
- keypad
 - numeric, 39

L

- labels
 - Microsoft Windows, 9
 - Service Tag, 9
- line conditioners, 25

M

- memory
 - adding, 77
 - removing, 79
- Microsoft Windows label, 9
- Mini PCI card
 - installing, 81
- Mini PCI card, modem, and memory module cover
 - description, 20
 - system view, 20
- modem
 - adding, 84

- modem connector
 - description, 19
 - system view, 19
- module bay
 - about, 31
 - description, 17
 - swapping devices while the computer is running, 35
 - swapping devices while the computer is turned off, 32
 - system view, 17

N

- network
 - fixing problems, 54
- network connector
 - description, 18
 - system view, 18

O

- operating system
 - reinstalling, 71
 - reinstalling Windows XP, 71

P

- PC Card slot
 - description, 15
 - system view, 15
- PC Cards
 - fixing problems, 66
- PC Restore, 71

- power
 - fixing problems, 31
 - protection devices, 25
 - turning off your computer, 26

- power button
 - description, 11
 - system view, 11

- printer
 - cable, 23
 - connecting, 23
 - setting up, 23
 - USB, 23

- problems
 - restore to previous state, 71

- programs
 - crashes, 66
 - fixing problems, 66
 - not responding, 67

R

- RAM. *See* memory

- reinstalling
 - drivers, 70
 - Windows XP, 71

S

- security cable slot
 - description, 16-17
 - system view, 16-17

- Service Tag, 9

- Setup Diagram, 9

- shutting down your computer, 26

- software
 - fixing problems, 66
 - reinstalling software, 70

- speakers
 - description, 13
 - system view, 13

- specifications, system, 89

- surge protectors, 25

- S-video TV-out connector
 - description, 18
 - system view, 18

- System Restore, 71

- system setup program
 - commonly used options, 96
 - purpose, 95
 - screens, 96
 - viewing, 96

- system specifications, 89

- system views
 - back, 17
 - bottom, 17, 20
 - front, 11
 - left side, 15
 - right side, 16

T

- Tell Me How help file
 - accessing, 61

- touch pad, 42
 - customizing, 43
 - description, 13
 - system view, 13

- troubleshooting
 - about, 59
 - cannot save to floppy disk, 64
 - conflicts, 74
 - Device Driver Rollback, 70
 - drivers, 69
 - dropped or damaged
 - computer, 68
 - e-mail problems, 67
 - external keyboard
 - problems, 44
 - Hardware Troubleshooter, 74
 - Help and Support Center, 10
 - network problems, 54
 - PC Card problems, 66
 - power problems, 31
 - program crash, 66
 - program stopped
 - responding, 67
 - restore to previous state, 71
 - scanner problems, 64
 - unexpected characters, 44
 - wet computer, 67

- turning off your computer, 26

TV

- connecting, 47

U

- UPS, 26

- USB connector
 - description, 18
 - system view, 18

V

- video connector
 - description, 19
 - system view, 19

W

- wet computer, 67
- Windows XP
 - Device Driver Rollback, 70
 - Hardware Troubleshooter, 74
 - help, 61
 - Help and Support Center, 10
 - reinstalling, 71
 - System Restore, 71